

ArcelorMittal Sheet Piling



ArcelorMittal

Steel Foundation Solutions

General Catalogue 2021



Think steel first!



Water transport solutions

Build sustainable and durable maritime port and waterway infrastructures with our steel solutions. Quay walls made with steel sheet piles allow **up to 20% faster construction and 15% lower cost*** when compared with alternative materials. Steel is also the material of choice for breakwaters, dolphins, locks and canals.

The lifetime return on investment of ports built with ArcelorMittal AZ[®] steel sheet piles exceeds by 8%* the financial result brought by concrete solutions. **AMLoCor[®] steel grades are up to 5 times more corrosion-resistant** than standard steel grades, allowing optimised designs with service life of up to 100 years.

A specific Environmental Product Declaration based on comprehensive Life Cycle Analyses is available for ArcelorMittal steel sheet piles and EcoSheetPiles™ made of 100% recycled steel. With the intrinsic ductility of steel, sheet piling solutions in conjunction with modern performance-based design methods help design and optimise safe ports in seismic areas.

* Results from a study by Tractebel, Belgium (2019).

Water based transport is essential to our global economy

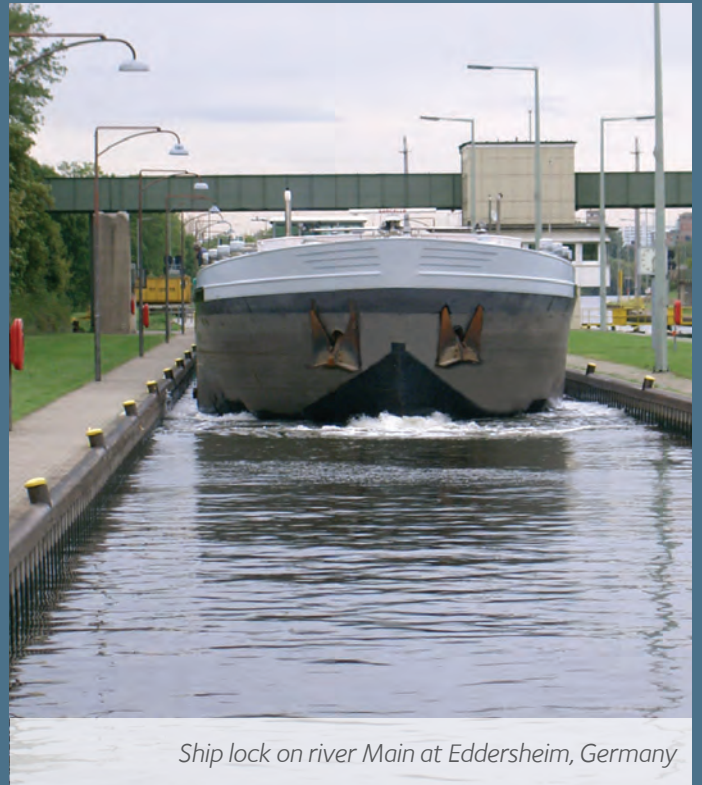

Ship lock on river Main at Eddersheim, Germany

Hazard protection solutions

Dykes, flood and erosion protection barriers made with steel sheet piles are one of the most efficient ways of protecting against floods and rising sea levels.

A new design method for reinforcements and upgrades of existing flood protection systems using steel sheet piles leads to up to 40% savings*.

Requiring little equipment and manpower, **steel sheet piles can be quickly installed** with guaranteed quality, even in remote locations.

AZ[®]-800, the widest sheet piles on the market, allow up to 14% less installation time. Dixeran[®] declutching detectors ensure against the loss of integrity of a sheet pile wall. Sealing systems such as AKILA[®] improve the imperviousness of the structures.

* Recent study by multi-disciplinary research team in the Netherlands (POV Macrostability, 2020).

Safeguarding our communities from natural disasters



Flood protection barrier protecting the city of St-Pierre de Gaubert, France

Mobility infrastructure solutions

Composite bridges with steel sheet pile abutments have **up to 10% shorter construction time and up to 15% less economic impact** on the community throughout their service life*. The use of steel sheet piles as load-bearing impervious permanent retaining walls in underground car parks maximizes the available surface inside the building. Permanent steel sheet pile walls in underground car parks of 2 to 3 levels are **up to 50% more cost-effective**** than walls built with alternative materials, with significantly shorter execution time. Silent and low vibration installation techniques minimise disruption in urban settings. **Steel sheet piles can be reused several times and are recyclable**, reducing the global environmental impact of projects.

* Study by Karlsruher Institut für Technologie (KIT), Germany (2019).

** Study by Royal Haskoning DHV, the Netherlands (2019).

Efficient and reliable mobility infrastructures make your journey smoother and safer



Underground car park with permanent steel sheet pile walls at Hopmarkt shopping center, Aalst, Belgium

Environmental protection solutions

Steel sheet piles are used as temporary and permanent retaining walls for landfill conversion, polluted soil remediation, riverbed cleaning operations and pollution containment. **Sealing systems such as AKILA® ensure the retaining walls are impervious**, while suitable for contact with groundwater.

Enclosures retaining contaminated soils can be created even faster with the **unique 800 mm wide AZ®-800 steel sheet piles**.

ArcelorMittal EcoSheetPiles™ have a much lower carbon footprint than other steel sheet piles*. EcoSheetPiles are the ideal solution to reduce the environmental impact of all retaining walls.

* Environmental Product Declaration for EcoSheetPiles™ (2018), based on a life-cycle analysis with "cradle-to-gate with options" methodology.

When faced with pollution risks, containment is vital



Fish pass at Sauveterre hydroelectric dam on river Rhône, France, allowing the restoration of the migration path of several fish and wildlife species. © Juan Robert

Contents



New ferry pier built with HZ[®]-M combined wall | Port of Calais | FR

© Calais Port, 2015

Introduction	6
Z-Sections	8
U-Sections	18
HZ [®] / AZ [®] combined wall system	28
AS 500 [®] straight web sections	31
Box piles	35
Jagged wall	40
Combined walls	43
Steel tubes for foundations	46
Driving caps	47
HP piles	50
Durability of steel sheet piles	51
AMLoCor [®]	54
Watertightness	55
AKILA [®] sealing system	56
Sustainability & EPD	57
Delivery conditions	59
Documentation	62

Introduction

ArcelorMittal is the largest steel and mining company in the world. ArcelorMittal is also the world's leading manufacturer of hot rolled steel sheet piles. ArcelorMittal Sheet Piling oversees the sales, marketing and promotion of foundation solutions that include the following products manufactured in these ArcelorMittal mills:

- hot rolled steel sheet piles: Belval and Differdange in Luxembourg, Dabrowa in Poland;
- cold formed steel sheet piles: "Palfroid" in Messempré, France;
- steel tubes (for foundations): Dintelmond, The Netherlands (for EU markets);
- steel bearing piles: Belval and Differdange in Luxembourg.

ArcelorMittal Sheet Piling offers a complete solution package, that includes also accessories (such as anchoring material, walers, fabricated piles, driving caps, etc.) with a full technical support from the conceptual design to the final installation process and additional features and services (such as special fabrications, coating, sealant material for the interlocks, etc).

ArcelorMittal Belval is the world's largest rolling mill of hot rolled steel sheet piles and has been playing a leading role in the development of piling technology for over 100 years. The first steel sheet piles were rolled in 1911 and 1912: the "Ransome" and "Terre Rouge" piles. Since then, the product range of ArcelorMittal's mill in Belval has undergone constant improvement and development to include AZ[®] sections up to 800 mm wide and U-type sections up to 750 mm wide (AU). One rolling mill in Belval is dedicated solely to the production of steel sheet piles.

ArcelorMittal Differdange produces the large HZ[®]-M sections to form the most competitive HZ/AZ high section modulus combined wall system.

ArcelorMittal Dabrowa manufactures a wide range of hot rolled U-type sheet piles.

ArcelorMittal steel sheet piles are manufactured in Europe. Our values are sustainability, quality and leadership. We offer the most complete range of products and services, focused on bringing the most added-value to our customers. ArcelorMittal Sheet Piling provides cost-competitive solutions and certified quality for its customers, while considering society's expectations for a more circular and less carbon-intensive economy.

ArcelorMittal's piling series are especially suitable for quickly and reliably building cost-effective structures. They are characterised by excellent section properties, for instance

a highly competitive ratio of section modulus to weight, as well as high moments of inertia. Steel sheet piles and foundation products are manufactured according to the European standards, but they can also be supplied according to other international standards (e.g. ASTM).

EcoSheetPile™ are produced from 100% recycled, recyclable and reusable steel. They are a major contributor to the circular economy.

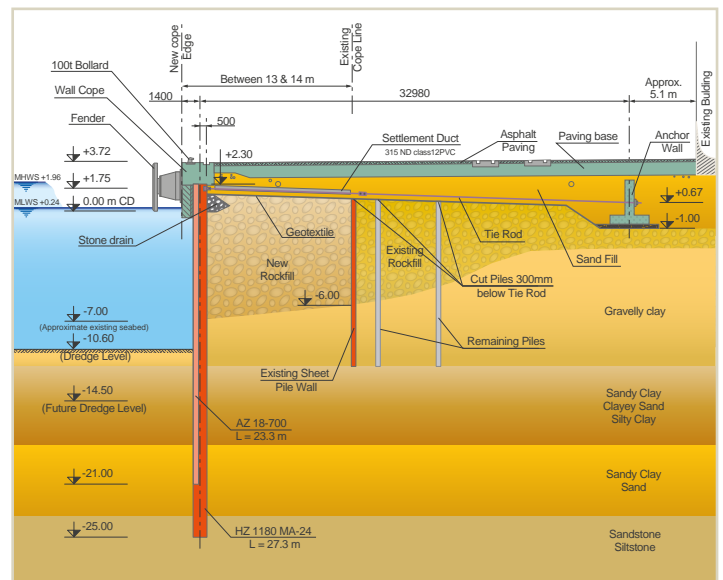

Preliminary design for a quay wall



Belval steel works, Luxembourg, 1930s



Sheet pile catalogues, 1912

Z-Sections

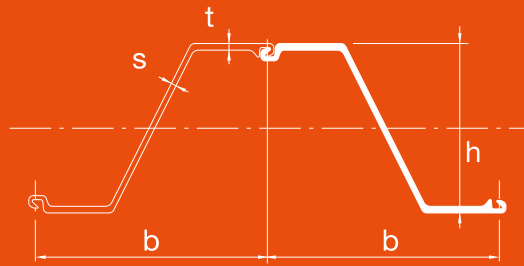

The essential characteristics of Z-sections include the continuous form of the web and the location of the interlock symmetrically on each side of the neutral axis. Both aspects create a positive influence on the section modulus. The AZ® series, a section with extraordinary characteristics and the proven qualities of the Larssen interlock, has the following advantages:

- extremely competitive section-modulus-to-mass ratio;
- increased inertia for reduced deflection;
- large width, resulting in competitive installation performance;
- good corrosion resistance, the steel being thickest at the critical corrosion points.

Section	Width		Height		Thickness		Sectional area cm ² /m	Mass		Moment of inertia cm ⁴ /m	Elastic section modulus cm ³ /m	Static moment cm ³ /m	Plastic section modulus cm ³ /m	Class ¹⁾							
	b mm	h mm	t mm	s mm	single pile kg/m	wall kg/m ²		S240 GP	S270 GP					S320 GP	S355 GP	S390 GP	S430 GP	S460 AP			
AZ®-800																					
AZ 18-800	800	449	8.5	8.5	129	80.7	101	41320	1840	1065	2135	3	3	3	3	3	4	4			
AZ 20-800	800	450	9.5	9.5	141	88.6	111	45050	2000	1165	2330	3	3	3	3	3	3	3			
AZ 22-800	800	451	10.5	10.5	153	96.4	120	48790	2165	1260	2525	2	2	3	3	3	3	3			
AZ 23-800	800	474	11.5	9.0	151	94.6	118	55260	2330	1340	2680	2	2	2	3	3	3	3			
AZ 25-800	800	475	12.5	10.0	163	102.6	128	59410	2500	1445	2890	2	2	2	2	2	3	3			
AZ 27-800	800	476	13.5	11.0	176	110.5	138	63570	2670	1550	3100	2	2	2	2	2	2	2			
AZ®-750																					
AZ 28-750	750	509	12.0	10.0	171	100.8	134	71540	2810	1620	3245	2	2	2	2	3	3	3			
AZ 30-750	750	510	13.0	11.0	185	108.8	145	76670	3005	1740	3485	2	2	2	2	2	2	3			
AZ 32-750	750	511	14.0	12.0	198	116.7	156	81800	3200	1860	3720	2	2	2	2	2	2	2			
AZ®-700 and AZ®-770																					
AZ 12-770	770	344	8.5	8.5	120	72.6	94	21430	1245	740	1480	2	2	3	3	3	3	3			
AZ 13-770	770	344	9.0	9.0	126	76.1	99	22360	1300	775	1546	2	2	3	3	3	3	3			
AZ 14-770	770	345	9.5	9.5	132	79.5	103	23300	1355	805	1611	2	2	2	2	3	3	3			
AZ 14-770-10/10	770	345	10.0	10.0	137	82.9	108	24240	1405	840	1677	2	2	2	2	2	3	3			
AZ 12-700	700	314	8.5	8.5	123	67.7	97	18880	1205	710	1415	2	2	3	3	3	3	3			
AZ 13-700	700	315	9.5	9.5	135	74.0	106	20540	1305	770	1540	2	2	2	3	3	3	3			
AZ 13-700-10/10	700	316	10.0	10.0	140	77.2	110	21370	1355	800	1600	2	2	2	2	3	3	3			
AZ 14-700	700	316	10.5	10.5	146	80.3	115	22190	1405	835	1665	2	2	2	2	2	3	3			
AZ 17-700	700	420	8.5	8.5	133	73.1	104	36230	1730	1015	2027	2	2	3	3	3	3	3			
AZ 18-700	700	420	9.0	9.0	139	76.5	109	37800	1800	1060	2116	2	2	3	3	3	3	3			
AZ 19-700	700	421	9.5	9.5	146	80.0	114	39380	1870	1105	2206	2	2	2	3	3	3	3			
AZ 20-700	700	421	10.0	10.0	152	83.5	119	40960	1945	1150	2296	2	2	2	2	2	3	3			
AZ 24-700	700	459	11.2	11.2	174	95.7	137	55820	2430	1435	2867	2	2	2	2	2	2	3			
AZ 26-700	700	460	12.2	12.2	187	102.9	147	59720	2600	1535	3070	2	2	2	2	2	2	2			
AZ 28-700	700	461	13.2	13.2	200	110.0	157	63620	2760	1635	3273	2	2	2	2	2	2	2			

Section	Width b mm	Height h mm	Thickness		Sectional area cm ² /m	Mass		Moment of inertia cm ⁴ /m	Elastic section modulus cm ³ /m	Static moment cm ³ /m	Plastic section modulus cm ³ /m	Class ¹⁾							
			t mm	s mm		single pile kg/m	wall kg/m ²					S 240 GP	S 270 GP	S 320 GP	S 355 GP	S 390 GP	S 430 GP	S 460 AP	
AZ[®]-700 and AZ[®]-770																			
AZ 36-700N	700	499	15.0	11.2	216	118.6	169	89610	3590	2055	4110	2	2	2	2	2	2		
AZ 38-700N	700	500	16.0	12.2	230	126.4	181	94840	3795	2180	4360	2	2	2	2	2	2		
AZ 40-700N	700	501	17.0	13.2	244	134.2	192	100080	3995	2305	4605	2	2	2	2	2	2		
AZ 42-700N	700	499	18.0	14.0	259	142.1	203	104930	4205	2425	4855	2	2	2	2	2	2		
AZ 44-700N	700	500	19.0	15.0	273	149.9	214	110150	4405	2550	5105	2	2	2	2	2	2		
AZ 46-700N	700	501	20.0	16.0	287	157.7	225	115370	4605	2675	5350	2	2	2	2	2	2		
AZ 48-700	700	503	22.0	15.0	288	158.5	226	119650	4755	2745	5490	2	2	2	2	2	2		
AZ 50-700	700	504	23.0	16.0	303	166.3	238	124890	4955	2870	5735	2	2	2	2	2	2		
AZ 52-700	700	505	24.0	17.0	317	174.1	249	130140	5155	2990	5985	2	2	2	2	2	2		
AZ[®]																			
AZ 18 ²⁾	630	380	9.5	9.5	150	74.4	118	34200	1800	1050	2104	2	2	2	3	3	3		
AZ 18-10/10	630	381	10.0	10.0	157	77.8	123	35540	1870	1095	2189	2	2	2	2	3	3		
AZ 26 ²⁾	630	427	13.0	12.2	198	97.8	155	55510	2600	1530	3059	2	2	2	2	2	2		

¹⁾ Classification according to EN 1993-5. Class 1 is obtained by verification of the rotation capacity for a class-2 cross-section.

²⁾ Can be rolled-up or down by 0.5 mm and 1.0 mm on request.

A set of tables with all the data required for design in accordance with EN 1993-5 is available from our Technical Department. Tailor made profiles can be rolled on request.



Section	S = Single pile D = Double pile	Sectional area	Mass	Moment of inertia	Elastic section modulus	Radius of gyration	Coating area ¹⁾
AZ®-800							
AZ 18-800	Per S	102.9	80.7	33055	1470	17.93	1.04
	Per D	205.7	161.5	66110	2945	17.93	2.08
	Per m of wall	128.6	100.9	41320	1840	17.93	1.30
AZ 20-800	Per S	112.8	88.6	36040	1600	17.87	1.04
	Per D	225.6	177.1	72070	3205	17.87	2.08
	Per m of wall	141.0	110.7	45050	2000	17.87	1.30
AZ 22-800	Per S	122.8	96.4	39035	1730	17.83	1.04
	Per D	245.6	192.8	78070	3460	17.83	2.08
	Per m of wall	153.5	120.5	48790	2165	17.83	1.30
AZ 23-800	Per S	120.5	94.6	44200	1865	19.15	1.06
	Per D	241.0	189.2	88410	3730	19.15	2.11
	Per m of wall	150.6	118.2	55260	2330	19.15	1.32
AZ 25-800	Per S	130.6	102.6	47530	2000	19.07	1.06
	Per D	261.3	205.1	95060	4005	19.07	2.11
	Per m of wall	163.3	128.2	59410	2500	19.07	1.32
AZ 27-800	Per S	140.8	110.5	50860	2135	19.01	1.06
	Per D	281.6	221.0	101720	4275	19.01	2.11
	Per m of wall	176.0	138.1	63570	2670	19.01	1.32
AZ®-750							
AZ 28-750	Per S	128.4	100.8	53650	2110	20.44	1.06
	Per D	256.8	201.6	107310	4215	20.44	2.11
	Per m of wall	171.2	134.4	71540	2810	20.44	1.41
AZ 30-750	Per S	138.5	108.8	57500	2255	20.37	1.06
	Per D	277.1	217.5	115000	4510	20.37	2.11
	Per m of wall	184.7	145.0	76670	3005	20.37	1.41
AZ 32-750	Per S	148.7	116.7	61350	2400	20.31	1.06
	Per D	297.4	233.5	122710	4805	20.31	2.11
	Per m of wall	198.3	155.6	81800	3200	20.31	1.41

¹⁾ One side, excluding inside of interlocks.

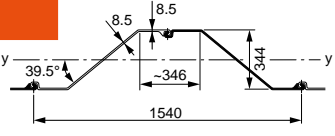
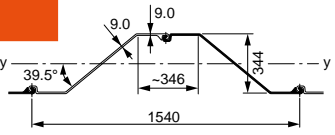
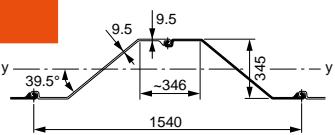
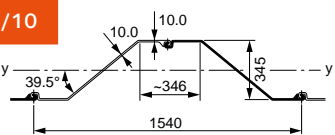
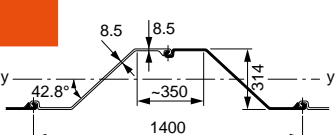
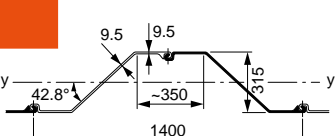
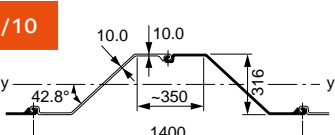
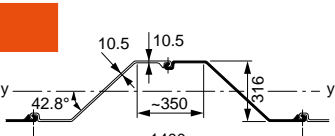
Section	S = Single pile D = Double pile	Sectional area cm ²	Mass kg/m	Moment of inertia cm ⁴	Elastic section modulus cm ³	Radius of gyration cm	Coating area ¹⁾ m ² /m
AZ[®]-700 and AZ[®]-770							
AZ 12-770 	Per S	92.5	72.6	16500	960	13.36	0.93
	Per D	185.0	145.2	33000	1920	13.36	1.85
	Per m of wall	120.1	94.3	21430	1245	13.36	1.20
AZ 13-770 	Per S	96.9	76.1	17220	1000	13.33	0.93
	Per D	193.8	152.1	34440	2000	13.33	1.85
	Per m of wall	125.8	98.8	22360	1300	13.33	1.20
AZ 14-770 	Per S	101.3	79.5	17940	1040	13.31	0.93
	Per D	202.6	159.0	35890	2085	13.31	1.85
	Per m of wall	131.5	103.2	23300	1355	13.31	1.20
AZ 14-770-10/10 	Per S	105.6	82.9	18670	1085	13.30	0.93
	Per D	211.2	165.8	37330	2165	13.30	1.85
	Per m of wall	137.2	107.7	24240	1405	13.30	1.20
AZ 12-700							
	Per S	86.2	67.7	13220	840	12.38	0.86
	Per D	172.5	135.4	26440	1685	12.38	1.71
	Per m of wall	123.2	96.7	18880	1205	12.38	1.22
AZ 13-700 	Per S	94.3	74.0	14370	910	12.35	0.86
	Per D	188.5	148.0	28750	1825	12.35	1.71
	Per m of wall	134.7	105.7	20540	1305	12.35	1.22
AZ 13-700-10/10 	Per S	98.3	77.2	14960	945	12.33	0.86
	Per D	196.6	154.3	29910	1895	12.33	1.71
	Per m of wall	140.4	110.2	21370	1355	12.33	1.22
AZ 14-700 	Per S	102.3	80.3	15530	980	12.32	0.86
	Per D	204.6	160.6	31060	1965	12.32	1.71
	Per m of wall	146.1	114.7	22190	1405	12.32	1.22

¹⁾ One side, excluding inside of interlocks.

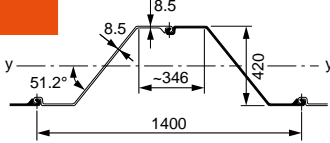
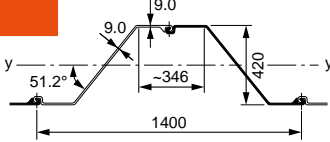
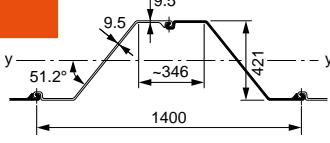
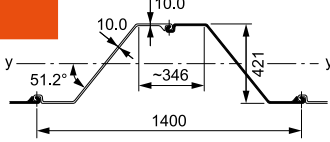
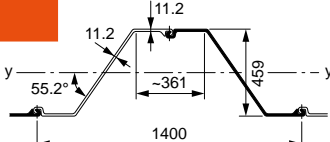
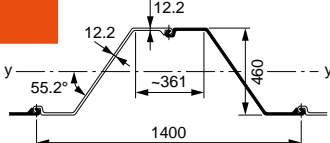
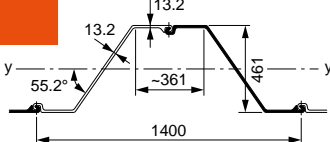
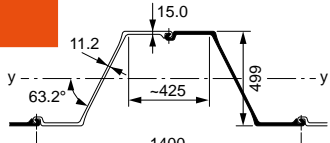
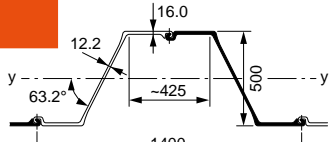
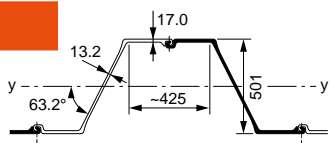
Section	S = Single pile D = Double pile	Sectional area	Mass	Moment of inertia	Elastic section modulus	Radius of gyration	Coating area ¹⁾	
								cm ²
AZ[®]-700 and AZ[®]-770								
AZ 17-700		Per S	93.1	73.1	25360	1210	16.50	0.93
		Per D	186.2	146.2	50720	2420	16.50	1.86
		Per m of wall	133.0	104.4	36230	1730	16.50	1.33
AZ 18-700		Per S	97.5	76.5	26460	1260	16.47	0.93
		Per D	194.9	153.0	52920	2520	16.47	1.86
		Per m of wall	139.2	109.3	37800	1800	16.47	1.33
AZ 19-700		Per S	101.9	80.0	27560	1310	16.44	0.93
		Per D	203.8	160.0	55130	2620	16.44	1.86
		Per m of wall	145.6	114.3	39380	1870	16.44	1.33
AZ 20-700		Per S	106.4	83.5	28670	1360	16.42	0.93
		Per D	212.8	167.0	57340	2725	16.42	1.86
		Per m of wall	152.0	119.3	40960	1945	16.42	1.33
AZ 24-700		Per S	121.9	95.7	39080	1700	17.90	0.97
		Per D	243.8	191.4	78150	3405	17.90	1.93
		Per m of wall	174.1	136.7	55820	2430	17.90	1.38
AZ 26-700		Per S	131.0	102.9	41800	1815	17.86	0.97
		Per D	262.1	205.7	83610	3635	17.86	1.93
		Per m of wall	187.2	146.9	59720	2600	17.86	1.38
AZ 28-700		Per S	140.2	110.0	44530	1930	17.83	0.97
		Per D	280.3	220.1	89070	3865	17.83	1.93
		Per m of wall	200.2	157.2	63620	2760	17.83	1.38
AZ 36-700N		Per S	151.1	118.6	62730	2510	20.37	1.03
		Per D	302.2	237.3	125450	5030	20.37	2.05
		Per m of wall	215.9	169.5	89610	3590	20.37	1.47
AZ 38-700N		Per S	161.0	126.4	66390	2655	20.31	1.03
		Per D	322.0	252.8	132780	5310	20.31	2.05
		Per m of wall	230.0	180.6	94840	3795	20.31	1.47
AZ 40-700N		Per S	170.9	134.2	70060	2795	20.25	1.03
		Per D	341.9	268.4	140110	5595	20.25	2.05
		Per m of wall	244.2	191.7	100080	3995	20.25	1.47

¹⁾ One side, excluding inside of interlocks.

Section	S = Single pile D = Double pile	Sectional area	Mass	Moment of inertia	Elastic section modulus	Radius of gyration	Coating area ¹⁾
AZ[®]-700 and AZ[®]-770							
AZ 42-700N	Per S	181.1	142.1	73450	2945	20.14	1.03
	Per D	362.1	284.3	146900	5890	20.14	2.06
	Per m of wall	258.7	203.1	104930	4205	20.14	1.47
AZ 44-700N	Per S	191.0	149.9	77100	3085	20.09	1.03
	Per D	382.0	299.8	154210	6170	20.09	2.06
	Per m of wall	272.8	214.2	110150	4405	20.09	1.47
AZ 46-700N	Per S	200.9	157.7	80760	3220	20.05	1.03
	Per D	401.8	315.4	161520	6450	20.05	2.06
	Per m of wall	287.0	225.3	115370	4605	20.05	1.47
AZ 48-700	Per S	201.9	158.5	83760	3330	20.37	1.02
	Per D	403.8	317.0	167510	6660	20.37	2.04
	Per m of wall	288.4	226.4	119650	4755	20.37	1.46
AZ 50-700	Per S	211.8	166.3	87430	3470	20.32	1.02
	Per D	423.6	332.5	174850	6940	20.32	2.04
	Per m of wall	302.6	237.5	124890	4955	20.32	1.46
AZ 52-700	Per S	221.7	174.1	91100	3610	20.27	1.02
	Per D	443.5	348.1	182200	7215	20.27	2.04
	Per m of wall	316.8	248.7	130140	5155	20.27	1.46

¹⁾ One side, excluding inside of interlocks.

Coastal defense project, Colwyn Bay, UK



© VolkerStevin | UK

Section	S = Single pile D = Double pile	Sectional area cm ²	Mass kg/m	Moment of inertia cm ⁴	Elastic section modulus cm ³	Radius of gyration cm	Coating area ¹⁾ m ² /m
AZ[®]							
AZ 18	Per S	94.8	74.4	21540	1135	15.07	0.86
	Per D	189.6	148.8	43080	2270	15.07	1.71
	Per m of wall	150.4	118.1	34200	1800	15.07	1.35
AZ 18-10/10	Per S	99.1	77.8	22390	1175	15.04	0.86
	Per D	198.1	155.5	44790	2355	15.04	1.71
	Per m of wall	157.2	123.4	35540	1870	15.04	1.35
AZ 26	Per S	124.6	97.8	34970	1640	16.75	0.90
	Per D	249.2	195.6	69940	3280	16.75	1.78
	Per m of wall	197.8	155.2	55510	2600	16.75	1.41

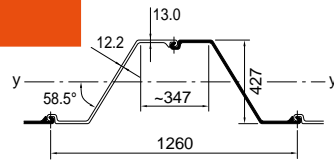
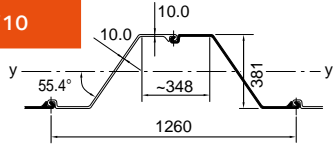
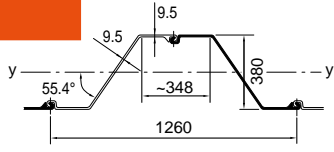

¹⁾ One side, excluding inside of interlocks.

Boardwalk, Aarschot, Belgium



Interlock

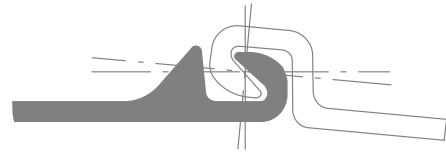

AZ® Larssen interlock in accordance with EN 10248. All available AZ sheet piles can be interlocked, as well as the AU, PU and GU (except GU-400). Theoretical interlock swing: $\alpha_{\max} = 5^\circ$.

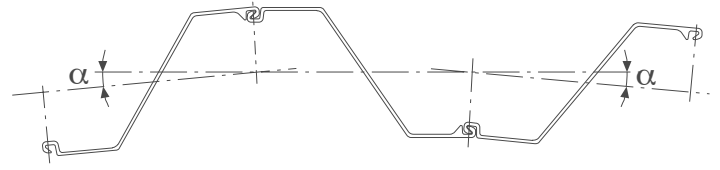

Delivery form

Single Pile
Position A

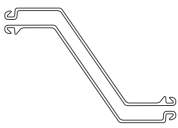

Single Pile
Position B

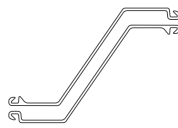

Double Pile
Form I (standard)

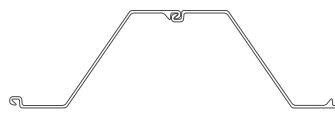

Double Pile
Form II (on request)

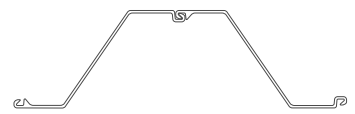

Bent piles

Maximum bending angle: $\beta = 25^\circ$. Z-piles are usually bent in the middle of the web. They are generally delivered as single piles. Double piles are available upon request.

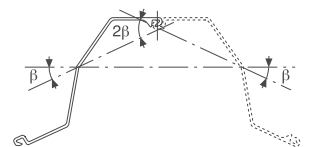
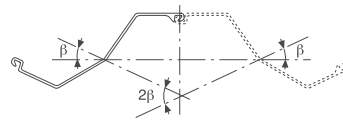

Corner sections

C 9

Mass ~ 9.3 kg/m
Coating area 0.15 m²/m

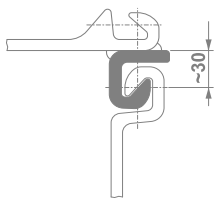

C 14

Mass ~ 14.4 kg/m
Coating area 0.22 m²/m

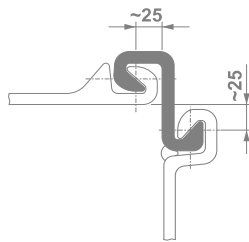

DELTA 13

Mass ~ 13.1 kg/m
Coating area 0.19 m²/m

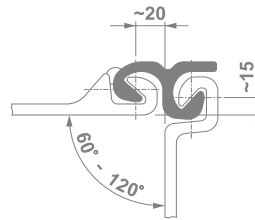

OMEGA 18

Mass ~ 18.0 kg/m
Coating area 0.24 m²/m

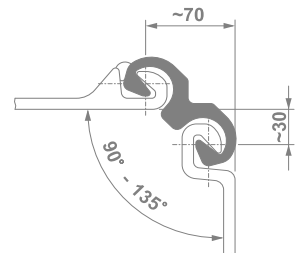

Special corner sections interlocking with U and Z-sections make it possible to form corner or junction piles without using fabricated special piles. Corner sections are fixed to the sheet pile in accordance with EN 12063.

Different welding specifications are available on request. The corner sections are threaded and welded with usually a 200 mm setback from the top of the piles.

Corner and junction piles

The following special piles, among others, are available as single and double piles on request.

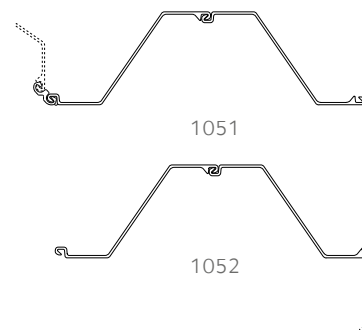
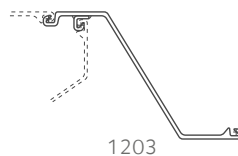
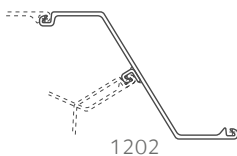
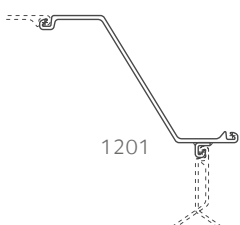

Crimping

Threaded AZ® double piles are recommended for facilitating the installation process. Although crimping of AZ double piles is not required for structural design reasons, most customers request crimping according to our standard specification for handling and driving.



- ¹⁾ Amount and layout of crimping points may differ at both ends. Special crimping on request.
²⁾ 6 crimping points per 2.1 m for the profiles AZ 38-700N, AZ 44-700N and AZ 50-700.
³⁾ 1400 mm for the profiles AZ 38-700N, AZ 44-700N and AZ 50-700.
⁴⁾ 2100 mm for the profiles AZ 38-700N, AZ 44-700N and AZ 50-700.

Pile length < 6 m:
 3 crimping points per 1.8 m
 = 1.7 crimping points per m¹⁾

Pile length ≥ 6 m:
 6 crimping points per 3.6 m²⁾
 = 1.7 crimping points per m¹⁾

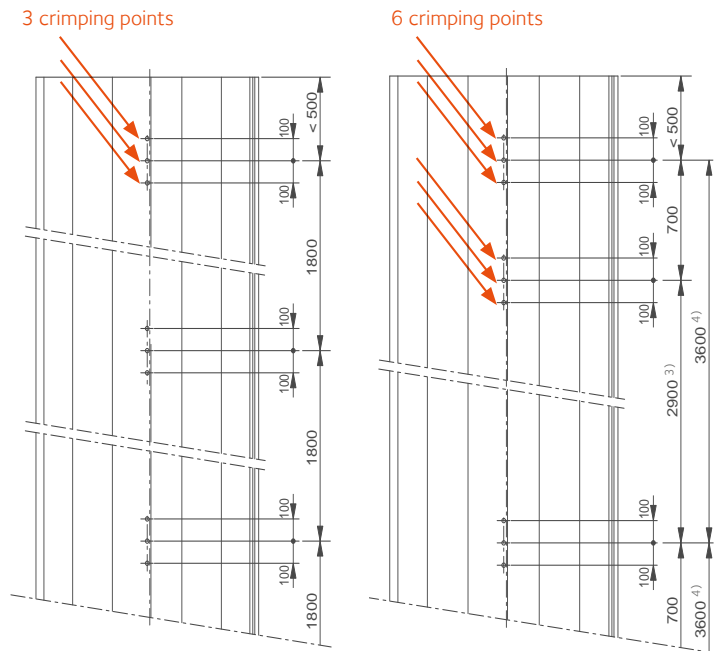

Tie back system

Most sheet pile retaining walls need supplementary support at the top, in addition to embedment in the soil. Temporary cofferdams generally use waler and strut bracing inside the excavation. Permanent or large retaining walls are often tied back to an anchor wall installed at a certain distance behind the main wall. Other anchor systems, like injection anchors or anchor piles are also common practice. The drawing shows a typical horizontal tie-rod connection for sheet pile walls. The following components can be seen:

- | | |
|-----------------------------|----------------------|
| 1 Plain tie-rod | 7 Waling |
| 2 Upset end tie-rod | 8 Spacer |
| 3 Nut | 9 Supporting bracket |
| 4 Turnbuckle | 10 Splicing plate |
| 5 Bearing plate | 11 Splicing bolt |
| 6 Bearing plate on concrete | 12 Fixing bolt |
| | 13 |
| | 14 Fixing plate |
| | 15 |

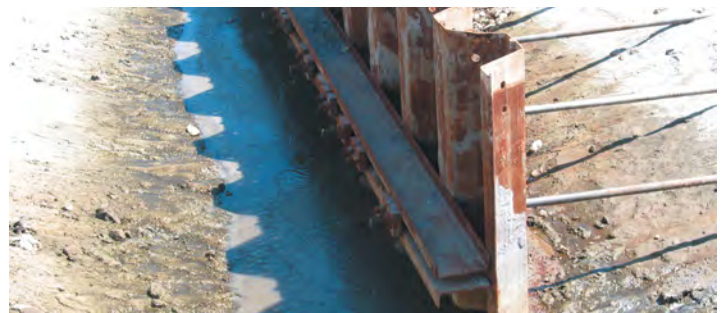
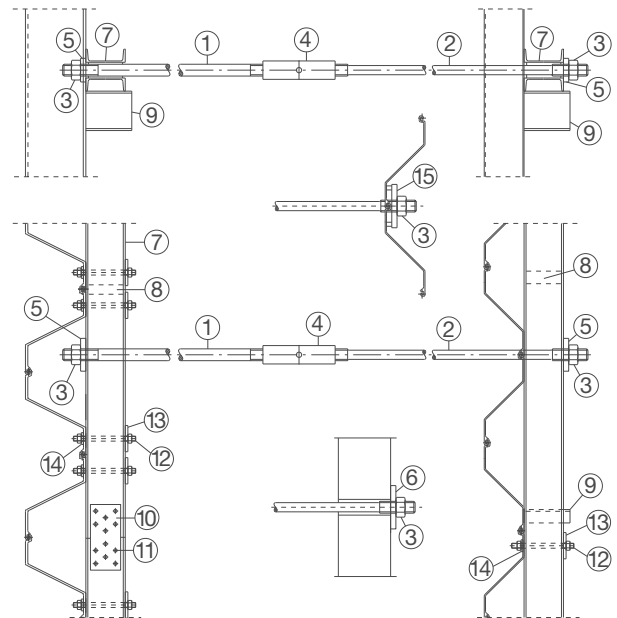

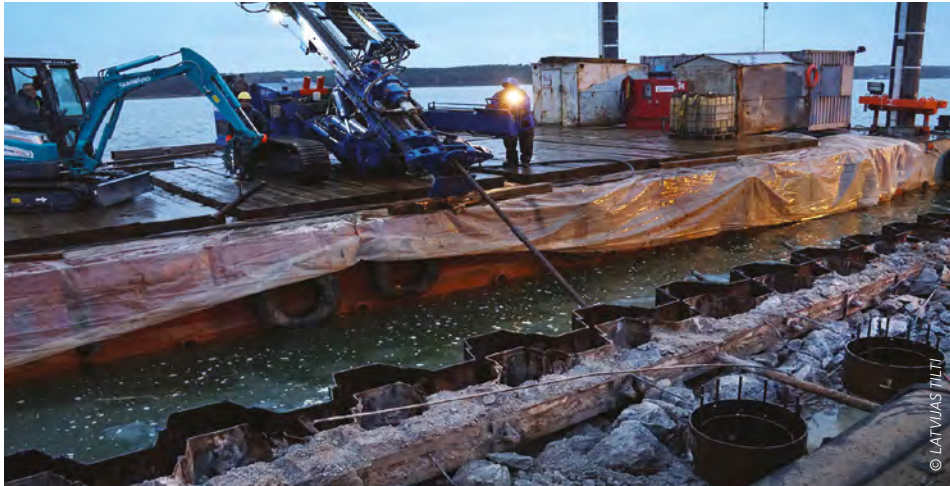

U-Sections

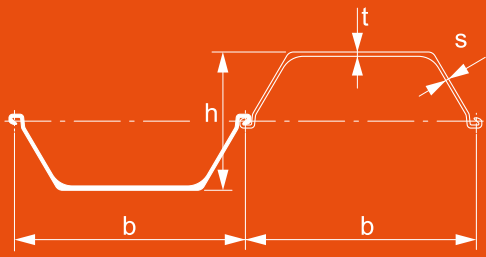

The advantages of U-sections include:

- a wide range of sections forming several series with various geometrical characteristics, allowing a technically and economically optimal choice for each specific project;
- the combination of great profile depth with large flange thickness giving excellent mechanical properties;
- the symmetrical form of the single element has made these sheet piles particularly convenient for re-use;
- the possibility of assembling and crimping the piles into pairs at the mill improves installation quality and performance;
- easy fixing of tie-rods and swivelling attachments, even under water;
- great corrosion resistance, with the steel section being thickest at the critical corrosion points.

Section	Width		Height		Thickness		Sectional area cm ² /m	Mass		Moment of inertia cm ⁴ /m	Elastic section modulus cm ³ /m	Static moment cm ³ /m	Plastic section modulus cm ³ /m	Class ¹⁾							
	b mm	h mm	t mm	s mm	single pile kg/m	wall kg/m ²		S 240 GP	S 270 GP					S 320 GP	S 355 GP	S 390 GP	S 430 GP	S 460 AP			
AU™ sections																					
AU 14	750	408	10.0	8.3	132	77.9	104	28680	1405	820	1663	2	2	3	3	3	3	3			
AU 16	750	411	11.5	9.3	147	86.3	115	32850	1600	935	1891	2	2	2	2	2	3	3			
AU 18	750	441	10.5	9.1	150	88.5	118	39300	1780	1030	2082	2	3	3	3	3	3	3			
AU 20	750	444	12.0	10.0	165	96.9	129	44440	2000	1155	2339	2	2	2	3	3	3	3			
AU 23	750	447	13.0	9.5	173	102.1	136	50700	2270	1285	2600	2	2	2	3	3	3	3			
AU 25	750	450	14.5	10.2	188	110.4	147	56240	2500	1420	2866	2	2	2	2	2	3	3			
PU® sections																					
PU 12	600	360	9.8	9.0	140	66.1	110	21600	1200	715	1457	-	-	-	2	2	2	3			
PU 12S	600	360	10.0	10.0	151	71.0	118	22660	1260	755	1543	-	-	-	2	2	2	2			
PU 18 ⁻¹	600	430	10.2	8.4	154	72.6	121	35950	1670	980	1988	2	2	2	2	2	3	3			
PU 18	600	430	11.2	9.0	163	76.9	128	38650	1800	1055	2134	2	2	2	2	2	2	2			
PU 18 ⁺¹	600	430	12.2	9.5	172	81.1	135	41320	1920	1125	2280	2	2	2	2	2	2	2			
PU 22 ⁻¹	600	450	11.1	9.0	174	81.9	137	46380	2060	1195	2422	2	2	2	2	2	3	3			
PU 22	600	450	12.1	9.5	183	86.1	144	49460	2200	1275	2580	2	2	2	2	2	2	2			
PU 22 ⁺¹	600	450	13.1	10.0	192	90.4	151	52510	2335	1355	2735	2	2	2	2	2	2	2			
PU 28 ⁻¹	600	452	14.2	9.7	207	97.4	162	60580	2680	1525	3087	2	2	2	2	2	2	2			
PU 28	600	454	15.2	10.1	216	101.8	170	64460	2840	1620	3269	2	2	2	2	2	2	2			
PU 28 ⁺¹	600	456	16.2	10.5	226	106.2	177	68380	3000	1710	3450	2	2	2	2	2	2	2			
PU 32 ⁻¹	600	452	18.5	10.6	233	109.9	183	69210	3065	1745	3525	2	2	2	2	2	2	2			
PU 32	600	452	19.5	11.0	242	114.1	190	72320	3200	1825	3687	2	2	2	2	2	2	2			
PU 32 ⁺¹	600	452	20.5	11.4	251	118.4	197	75410	3340	1905	3845	2	2	2	2	2	2	2			
GU® sections																					
GU 6N	600	309	6.0	6.0	89	41.9	70	9670	625	375	765	3	3	3	4	4	4	4			
GU 7N	600	310	6.5	6.4	94	44.1	74	10450	675	400	825	3	3	3	3	3	4	4			
GU 7S	600	311	7.2	6.9	98	46.3	77	11540	740	440	900	2	2	3	3	3	3	3			
GU 7HWS	600	312	7.3	6.9	101	47.4	79	11620	745	445	910	2	2	3	3	3	3	3			
GU 8N	600	312	7.5	7.1	103	48.5	81	12010	770	460	935	2	2	3	3	3	3	3			
GU 8S	600	313	8.0	7.5	108	50.8	85	12800	820	490	995	2	2	2	3	3	3	3			

Section	Width		Height		Thickness		Sectional area		Mass		Moment of inertia	Elastic section modulus	Static moment	Plastic section modulus	Class ¹⁾							
	b	h	t	s	cm ² /m	single pile	wall	cm ⁴ /m	cm ³ /m	cm ³ /m					cm ³ /m	S 240 GP	S 270 GP	S 320 GP	S 355 GP	S 390 GP	S 430 GP	S 460 AP
GU® sections																						
GU 10N	600	316	9.0	6.8	118	55.8	93	15700	995	565	1160	2	2	3	3	3	3	3				
GU 11N	600	318	10.0	7.4	128	60.2	100	17450	1095	630	1280	2	2	2	2	3	3	3				
GU 12N	600	320	11.0	8.0	137	64.6	108	19220	1200	690	1400	2	2	2	2	2	2	3				
GU 13N	600	418	9.0	7.4	127	59.9	100	26590	1270	755	1535	2	2	2	2	2	3	3				
GU 14N	600	420	10.0	8.0	136	64.3	107	29410	1400	830	1685	2	2	2	2	2	2	2				
GU 15N	600	422	11.0	8.6	146	68.7	115	32260	1530	910	1840	2	2	2	2	2	2	2				
GU 16N	600	430	10.2	8.4	154	72.6	121	35950	1670	980	1988	2	2	2	2	2	3	3				
GU 18N	600	430	11.2	9.0	163	76.9	128	38650	1800	1055	2134	2	2	2	2	2	2	2				
GU 20N	600	430	12.2	9.5	172	81.1	135	41320	1920	1125	2280	2	2	2	2	2	2	2				
GU 21N	600	450	11.1	9.0	174	81.9	137	46380	2060	1195	2422	2	2	2	2	2	3	3				
GU 22N	600	450	12.1	9.5	183	86.1	144	49460	2200	1275	2580	2	2	2	2	2	2	2				
GU 23N	600	450	13.1	10.0	192	90.4	151	52510	2335	1355	2735	2	2	2	2	2	2	2				
GU 27N	600	452	14.2	9.7	207	97.4	162	60580	2680	1525	3087	2	2	2	2	2	2	2				
GU 28N	600	454	15.2	10.1	216	101.8	170	64460	2840	1620	3269	2	2	2	2	2	2	2				
GU 30N	600	456	16.2	10.5	226	106.2	177	68380	3000	1710	3450	2	2	2	2	2	2	2				
GU 31N	600	452	18.5	10.6	233	109.9	183	69210	3065	1745	3525	2	2	2	2	2	2	2				
GU 32N	600	452	19.5	11.0	242	114.1	190	72320	3200	1825	3687	2	2	2	2	2	2	2				
GU 33N	600	452	20.5	11.4	251	118.4	197	75410	3340	1905	3845	2	2	2	2	2	2	2				
GU 16-400	400	290	12.7	9.4	197	62.0	155	22580	1560	885	1815	2	2	2	2	2	2	–				
GU 18-400	400	292	15.0	9.7	221	69.3	173	26090	1785	1015	2080	2	2	2	2	2	2	–				

The moment of inertia and section moduli values given assume correct shear transfer across the interlock.

¹⁾ Classification according to EN 1993-5. Class 1 is obtained by verification of the rotation capacity for a class 2 cross-section.

A set of tables with all the data required for design in accordance with EN 1993-5 is available from our Technical Department.

PU® sections can be rolled-up or -down by 0.5 mm and 1.0 mm. Tailor made profiles can be rolled on request.

Characteristics – AU™ sections

A weight reduction of about 10% compared to the 600 mm PU series has been achieved by optimising the geometric dimensions. The increased width **allows faster installation**, reduces the amount of coating required, due to the smaller perimeter, and increases watertightness thanks to fewer interlocks per metre of wall. Despite their greater width, the driving energy required for AU piles is not higher, thanks to their smooth and open shape and the patented radii at the web/flange connection.

Characteristics – PU® sections

PU sections are 600 mm wide U-piles manufactured in Belval. The shapes of the **PU 18**, **PU 22** and **PU 28** have been engineered with "reinforced shoulders" yielding the optimum section geometry **for hard driving conditions** as well as **multiple re-use**. Re-using steel sheet piles drastically improves the environmental impact of a steel solution.

Characteristics – GU® sections

ArcelorMittal's rolling mill in Dabrowa, Poland, produces hot rolled U-shaped steel sheet piles. The rolling mill has extended their portfolio during the last years with following sections: GU 7N, GU 14N, GU 18N, GU 22N, GU 28N, GU 32N and, in 2017, the GU 11N range.

Section	S = Single pile D = Double pile T = Triple pile	Sectional area	Mass	Moment of inertia	Elastic section modulus	Radius of gyration	Coating area ¹⁾
AU™ sections							
AU 14 	Per S	99.2	77.9	6590	457	8.15	0.96
	Per D	198.5	155.8	43020	2110	14.73	1.91
	Per T	297.7	233.7	59550	2435	14.15	2.86
	Per m of wall	132.3	103.8	28680	1405	14.73	1.27
	AU 16 	Per S	109.9	86.3	7110	481	8.04
Per D		219.7	172.5	49280	2400	14.98	1.91
Per T		329.6	258.7	68080	2750	14.37	2.86
Per m of wall		146.5	115.0	32850	1600	14.98	1.27
AU 18 		Per S	112.7	88.5	8760	554	8.82
	Per D	225.5	177.0	58950	2670	16.17	2.00
	Per T	338.2	265.5	81520	3065	15.53	2.99
	Per m of wall	150.3	118.0	39300	1780	16.17	1.33
	AU 20 	Per S	123.4	96.9	9380	579	8.72
Per D		246.9	193.8	66660	3000	16.43	2.00
Per T		370.3	290.7	92010	3425	15.76	2.99
Per m of wall		164.6	129.2	44440	2000	16.43	1.33
AU 23 		Per S	130.1	102.1	9830	579	8.69
	Per D	260.1	204.2	76050	3405	17.10	2.04
	Per T	390.2	306.3	104680	3840	16.38	3.05
	Per m of wall	173.4	136.1	50700	2270	17.10	1.36
	AU 25 	Per S	140.6	110.4	10390	601	8.60
Per D		281.3	220.8	84370	3750	17.32	2.04
Per T		422.0	331.3	115950	4215	16.58	3.05
Per m of wall		187.5	147.2	56240	2500	17.32	1.36
PU® sections							
PU 12 	Per S	84.2	66.1	4500	370	7.31	0.80
	Per D	168.4	132.2	25920	1440	12.41	1.59
	Per T	252.6	198.3	36060	1690	11.95	2.38
	Per m of wall	140.0	110.1	21600	1200	12.41	1.32
	PU 12S 	Per S	90.5	71.0	4830	400	7.30
Per D		181.0	142.1	27190	1510	12.26	1.59
Per T		271.5	213.1	37860	1780	11.81	2.38
Per m of wall		150.8	118.4	22660	1260	12.26	1.32

¹⁾ One side, excluding inside of interlocks.

Section	S = Single pile D = Double pile T = Triple pile	Sectional area	Mass	Moment of inertia	Elastic section modulus	Radius of gyration	Coating area ¹⁾	
								cm ²
PU® sections								
PU 18⁻¹		Per S	92.5	72.6	6960	475	8.67	0.87
		Per D	185.0	145.2	43140	2005	15.30	1.72
		Per T	277.5	217.8	59840	2330	14.69	2.58
		Per m of wall	154.2	121.0	35950	1670	15.30	1.43
PU 18		Per S	98.0	76.9	7220	485	8.58	0.87
		Per D	196.0	153.8	46380	2160	15.38	1.72
		Per T	294.0	230.7	64240	2495	14.78	2.58
		Per m of wall	163.3	128.2	38650	1800	15.38	1.43
PU 18⁺¹		Per S	103.4	81.1	7480	495	8.51	0.87
		Per D	206.8	162.3	49580	2305	15.49	1.72
		Per T	310.2	243.5	68600	2655	14.87	2.58
		Per m of wall	172.3	135.2	41320	1920	15.49	1.43
PU 22⁻¹		Per S	104.3	81.9	8460	535	9.01	0.90
		Per D	208.7	163.8	55650	2475	16.33	1.79
		Per T	313.0	245.7	77020	2850	15.69	2.68
		Per m of wall	173.9	136.5	46380	2060	16.33	1.49
PU 22		Per S	109.7	86.1	8740	546	8.93	0.90
		Per D	219.5	172.3	59360	2640	16.45	1.79
		Per T	329.2	258.4	82060	3025	15.79	2.68
		Per m of wall	182.9	143.6	49460	2200	16.45	1.49
PU 22⁺¹		Per S	115.2	90.4	9020	555	8.85	0.90
		Per D	230.4	180.9	63010	2800	16.54	1.79
		Per T	345.6	271.3	87020	3205	15.87	2.68
		Per m of wall	192.0	150.7	52510	2335	16.54	1.49
PU 28⁻¹		Per S	124.1	97.4	9740	576	8.86	0.93
		Per D	248.2	194.8	72700	3215	17.12	1.85
		Per T	372.3	292.2	100170	3645	16.40	2.77
		Per m of wall	206.8	162.3	60580	2680	17.12	1.54
PU 28		Per S	129.7	101.8	10070	589	8.81	0.93
		Per D	259.4	203.6	77350	3405	17.27	1.85
		Per T	389.0	305.4	106490	3850	16.55	2.77
		Per m of wall	216.1	169.6	64460	2840	17.27	1.54
PU 28⁺¹		Per S	135.3	106.2	10400	600	8.77	0.93
		Per D	270.7	212.5	82060	3600	17.41	1.85
		Per T	406.0	318.7	112870	4060	16.67	2.77
		Per m of wall	225.6	177.1	68380	3000	17.41	1.54

¹⁾ One side, excluding inside of interlocks.

Section	S = Single pile D = Double pile T = Triple pile	Sectional area cm ²	Mass kg/m	Moment of inertia cm ⁴	Elastic section modulus cm ³	Radius of gyration cm	Coating area ¹⁾ m ² /m
PU[®] sections							
PU 32⁻¹ 	Per S	140.0	109.9	10740	625	8.76	0.92
	Per D	280.0	219.8	83050	3675	17.22	1.83
	Per T	420.0	329.7	114310	4150	16.50	2.74
	Per m of wall	233.3	183.2	69210	3065	17.22	1.52
PU 32 	Per S	145.4	114.1	10950	633	8.68	0.92
	Per D	290.8	228.3	86790	3840	17.28	1.83
	Per T	436.2	342.4	119370	4330	16.54	2.74
	Per m of wall	242.3	190.2	72320	3200	17.28	1.52
PU 32⁺¹ 	Per S	150.8	118.4	11150	640	8.60	0.92
	Per D	301.6	236.8	90490	4005	17.32	1.83
	Per T	452.4	355.2	124370	4505	16.58	2.74
	Per m of wall	251.3	197.3	75410	3340	17.32	1.52

¹⁾ One side, excluding inside of interlocks.



Section	S = Single pile D = Double pile T = Triple pile	Sectional area	Mass	Moment of inertia	Elastic section modulus	Radius of gyration	Coating area ¹⁾
GU® sections							
GU 6N							
	Per S	53.4	41.9	2160	215	6.36	0.76
	Per D	106.8	83.8	11610	750	10.43	1.51
	Per T	160.2	125.7	16200	890	10.06	2.26
	Per m of wall	89.0	69.9	9670	625	10.43	1.26
GU 7N							
	Per S	56.2	44.1	2250	220	6.33	0.76
	Per D	112.4	88.2	12540	810	10.56	1.51
	Per T	168.6	132.4	17470	955	10.18	2.26
	Per m of wall	93.7	73.5	10450	675	10.56	1.26
GU 7S							
	Per S	58.9	46.3	2370	225	6.35	0.76
	Per D	117.9	92.5	13850	890	10.84	1.51
	Per T	176.8	138.8	19260	1045	10.44	2.26
	Per m of wall	98.2	77.1	11540	740	10.84	1.26
GU 7HWS							
	Per S	60.4	47.4	2380	225	6.28	0.76
	Per D	120.9	94.9	13940	895	10.74	1.51
	Per T	181.3	142.3	19390	1050	10.34	2.26
	Per m of wall	100.7	79.1	11620	745	10.74	1.26
GU 8N							
	Per S	61.8	48.5	2420	225	6.26	0.76
	Per D	123.7	97.1	14420	925	10.80	1.51
	Per T	185.5	145.6	20030	1080	10.39	2.26
	Per m of wall	103.1	80.9	12010	770	10.80	1.26
GU 8S							
	Per S	64.7	50.8	2510	230	6.23	0.76
	Per D	129.3	101.5	15360	980	10.90	1.51
	Per T	194.0	152.3	21320	1145	10.48	2.26
	Per m of wall	107.8	84.6	12800	820	10.90	1.26
GU 10N							
	Per S	71.1	55.8	3100	270	6.60	0.78
	Per D	142.2	111.6	18840	1190	11.51	1.55
	Per T	213.3	167.4	26150	1380	11.07	2.32
	Per m of wall	118.5	93.0	15700	995	11.51	1.29
GU 11N							
	Per S	76.7	60.2	3280	280	6.53	0.78
	Per D	153.4	120.4	20930	1315	11.68	1.55
	Per T	230.1	180.7	29010	1515	11.23	2.32
	Per m of wall	127.9	100.4	17450	1095	11.68	1.29
GU 12N							
	Per S	82.3	64.6	3450	290	6.47	0.78
	Per D	164.7	129.3	23060	1440	11.83	1.55
	Per T	247.0	193.9	31890	1650	11.36	2.32
	Per m of wall	137.2	107.7	19220	1200	11.83	1.29

¹⁾ One side, excluding inside of interlocks.

Section	S = Single pile D = Double pile T = Triple pile	Sectional area	Mass	Moment of inertia	Elastic section modulus	Radius of gyration	Coating area ¹⁾	
		cm ²	kg/m	cm ⁴	cm ³	cm	m ² /m	
GU[®] sections								
GU 27N		Per S	124.1	97.4	9740	576	8.86	0.93
		Per D	248.2	194.8	72700	3215	17.12	1.85
		Per T	372.3	292.2	100170	3645	16.40	2.77
		Per m of wall	206.8	162.3	60580	2680	17.12	1.54
GU 28N		Per S	129.7	101.8	10070	589	8.81	0.93
		Per D	259.4	203.6	77350	3405	17.27	1.85
		Per T	389.0	305.4	106490	3850	16.55	2.77
		Per m of wall	216.1	169.6	64460	2840	17.27	1.54
GU 30N		Per S	135.3	106.2	10400	600	8.77	0.93
		Per D	270.7	212.5	82060	3600	17.41	1.85
		Per T	406.0	318.7	112870	4060	16.67	2.77
		Per m of wall	225.6	177.1	68380	3000	17.41	1.54
GU 31N		Per S	140.0	109.9	10740	625	8.76	0.92
		Per D	280.0	219.8	83050	3675	17.22	1.83
		Per T	420.0	329.7	114310	4150	16.50	2.74
		Per m of wall	233.3	183.2	69210	3065	17.22	1.52
GU 32N		Per S	145.4	114.1	10950	633	8.68	0.92
		Per D	290.8	228.3	86790	3840	17.28	1.83
		Per T	436.2	342.4	119370	4330	16.54	2.74
		Per m of wall	242.3	190.2	72320	3200	17.28	1.52
GU 33N		Per S	150.8	118.4	11150	640	8.60	0.92
		Per D	301.6	236.8	90490	4005	17.32	1.83
		Per T	452.4	355.2	124370	4505	16.58	2.74
		Per m of wall	251.3	197.3	75410	3340	17.32	1.52
GU 16-400		Per S	78.9	62.0	2950	265	6.11	0.65
		Per D	157.9	123.9	18060	1245	10.70	1.28
		Per T	236.8	185.9	25060	1440	10.29	1.92
		Per m of wall	197.3	154.9	22580	1560	10.70	1.60
GU 18-400		Per S	88.3	69.3	3290	290	6.10	0.65
		Per D	176.7	138.7	20870	1430	10.87	1.28
		Per T	265.0	208.0	28920	1645	10.45	1.92
		Per m of wall	220.8	173.3	26090	1785	10.87	1.60

¹⁾ One side, excluding inside of interlocks.

Interlock

All AU™, PU® and GU® sheet piles feature Larssen interlocks in accordance with EN 10248. AU, PU and GU (except GU-400), as well as the AZ series, can be interlocked.

Theoretical interlock swing: $\alpha_{\max} = 5^\circ$

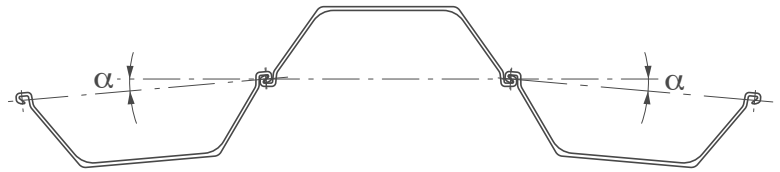

Delivery form

Single Pile

Double Pile
S-Form (standard)

Double Pile
Z-Form (on request)

Triple Pile

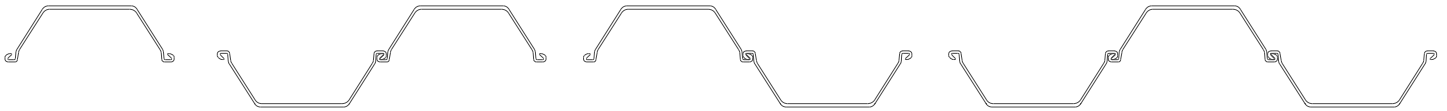

Bent piles

Maximum bending angle: $\beta = 25^\circ$. U-piles are bent in the middle of the flange. They are generally delivered as single piles. Double piles are available upon request.

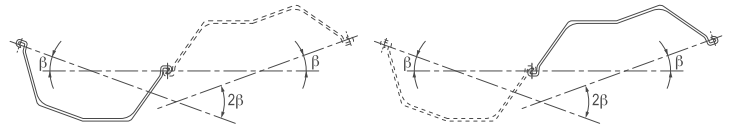

Corner sections

C 9

Mass ~ 9.3 kg/m
Coating area 0.15 m²/m

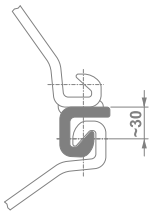

C 14

Mass ~ 14.4 kg/m
Coating area 0.22 m²/m

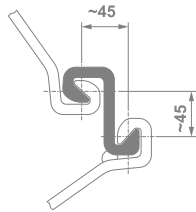

DELTA 13

Mass ~ 13.1 kg/m
Coating area 0.19 m²/m

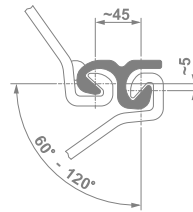

OMEGA 18

Mass ~ 18.0 kg/m
Coating area 0.24 m²/m

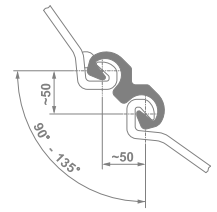

Special corner sections interlocking with U- and Z-sections make it possible to form corner or junction piles without using fabricated special piles. Corner sections are fixed to the sheet pile in accordance with EN 12063.

Different welding specifications are available on request. The corner sections are threaded and welded with usually a 200 mm setback from the top of the piles.

Fabricated piles, corner and junction piles

On request, arrangements can be made for widened or narrowed fabricated piles. The following special piles, among others, are available on request as single and double piles.

Narrowed pile

Widened pile

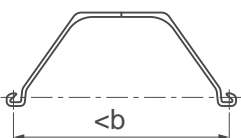

2501

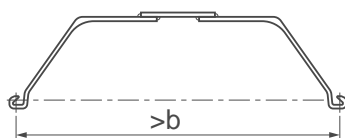

2511

2251



2061

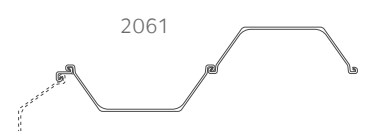

2253

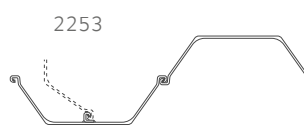

2071



2257



2151



Crimping

Contrary to Z-piles, the interlocks of U-piles have to transmit shear forces. To guarantee proper shear force transmission, ArcelorMittal's U-sections can be delivered as double piles with crimped interlocks.

See sketch for ArcelorMittal's standard crimping pattern. The allowable shear force per crimping point depends on the section and steel grade. A resistance per crimp of minimum 75 kN at a displacement of up to 5 mm can be achieved. The theoretical section properties of a continuous wall may have to be reduced even for double piles crimped²⁾.



¹⁾ Amount and layout of crimping points may differ at both ends. Special crimping on request.

²⁾ Based on EN1993-5. Please consult our Technical Department for more information.

AU standard crimping:
3 crimping points per 0.75 m
= 4 crimping points per m¹⁾

PU/GU standard crimping:
6 crimping points per 1.7 m
= 3.5 crimping points per m¹⁾

3 crimping points

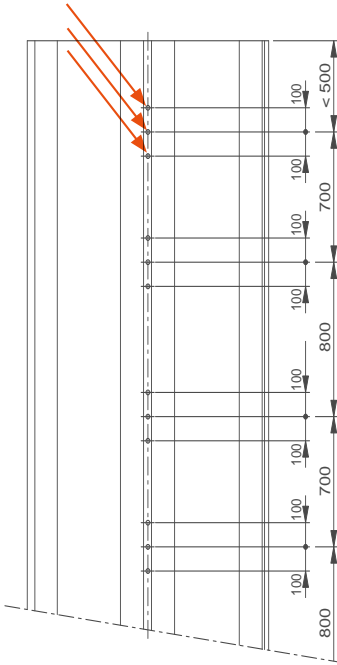

6 crimping points

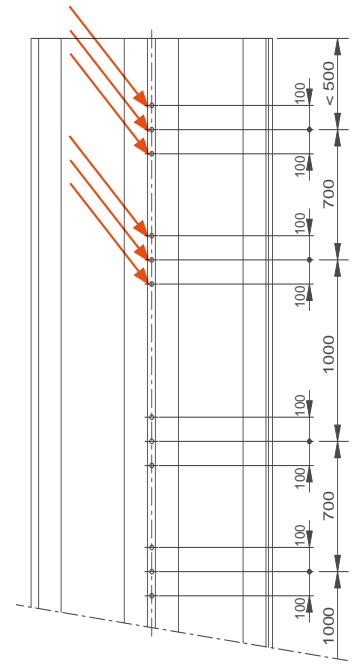

Tie back system

Most sheet pile retaining walls need supplementary support at the top, in addition to embedment in the soil. Temporary cofferdams generally use walers and struts (fixed or hydraulic) for cross-bracing inside the excavation. Permanent or large retaining walls are often tied back to an anchor wall installed at a certain distance behind the main wall. Injection anchors and anchor piles can also be used.

The drawing shows a typical horizontal tie-rod connection for U-section sheet pile walls.

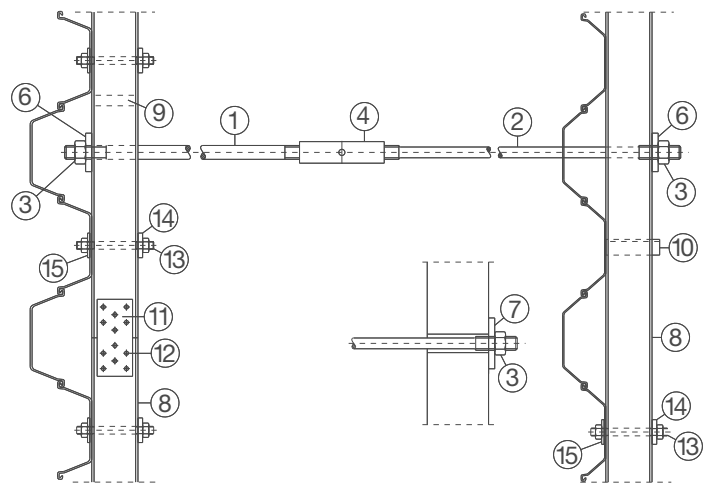
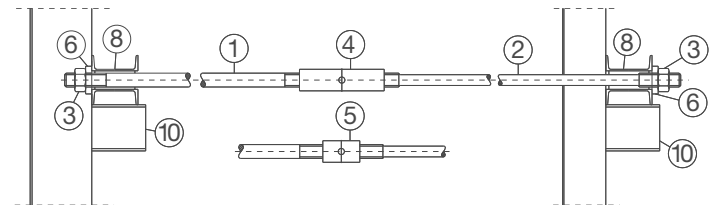

- | | | |
|---------------------|-----------------------------|------------------|
| 1 Plain tie-rod | 7 Bearing plate on concrete | 12 Splicing bolt |
| 2 Upset end tie-rod | 8 Waling | 13 Fixing bolt |
| 3 Nut | 9 Spacer | 14 Fixing plate |
| 4 Turnbuckle | 10 Supporting bracket | 15 Fixing plate |
| 5 Coupling sleeve | 11 Splicing plate | |
| 6 Bearing plate | | |

HZ[®] / AZ[®] combined wall system

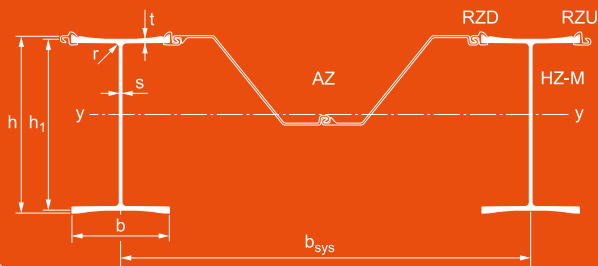

The HZ[®]-M combined wall is a revolutionary system, an extremely cost effective combined wall solution launched in 2008 to replace the former HZ/AZ system, and consists of:

- HZ[®]-M king piles;
- a pair of AZ[®] sheet piles as intermediary elements;
- special connectors (RH, RZD, RZU).

The HZ-M king piles, with milled grooves on the flanges and thicknesses up to 40 mm, fulfill two different structural functions:

- retaining members for soil and hydrostatic pressures;
- bearing piles for vertical loads.

The combinations are based on the same principle: structural supports comprising 1 or 2 HZ-M king pile sections alternating with or without intermediary double AZ sheet pile sections. The intermediary sheet piles have a soil-retaining and load-transferring function and are generally shorter than the HZ-M king piles. Depending on the combinations and steel grades adopted, the achievable bending moment capacity lies above 21 000 kNm/m (W_x up to 46 500 cm³/m).

Section (Sol. 102)	Dimensions							Torsional constant cm ⁴	Warping constant 10 ³ cm ⁶	Sectional area cm ²	Mass kg/m	Moment of inertia y-y cm ⁴	Elastic section modulus y-y cm ³	Coating area m ² /m	Connector set
	h mm	h ₁ mm	b mm	t _{max} mm	t mm	s mm	r mm								
HZ 630M ¹⁾	631.4	615.7	420	29.0	24.2	16.0	30	569.2	28410	308.6	242.2	217460	6985	2.870	A
HZ 880M A	831.3	803.4	458	29.0	18.9	13.0	20	347.2	58780	292.4	229.5	351350	8650	3.443	A
HZ 880M B	831.3	807.4	460	29.0	20.9	15.0	20	455.9	63190	324.7	254.9	386810	9480	3.448	A
HZ 880M C	831.3	811.4	460	29.0	22.9	15.0	20	531.9	66090	339.2	266.3	410830	10025	3.448	A
HZ 1080M A	1075.3	1047.4	454	29.0	19.6	16.0	30	525.9	98560	368.7	289.4	690560	13075	3.877	A
HZ 1080M B	1075.3	1053.4	454	29.0	22.6	16.0	30	656.5	106800	391.7	307.5	754830	14205	3.878	A
HZ 1080M C	1075.3	1059.4	456	29.0	25.7	18.0	30	876.2	114500	433.7	340.5	833250	15605	3.881	A
HZ 1080M D	1075.3	1067.4	457	30.7	29.7	19.0	30	1129.1	121000	467.7	367.2	909650	16920	3.882	A
HZ 1180M A	1075.4	-	458	34.7	31.0	20.0	30	1352.9	124600	494.9	388.5	967270	17865	3.884	A
HZ 1180M B	1079.4	-	458	36.7	33.0	20.0	30	1544.3	132400	512.1	402.0	1017000	18675	3.895	A
HZ 1180M C	1083.4	-	459	38.7	35.0	21.0	30	1817.9	142600	541.2	424.9	1081070	19790	3.905	B
HZ 1180M D	1087.4	-	460	40.7	37.0	22.0	30	2110.2	150000	568.1	445.9	1138630	20690	3.919	B

Connectors															
RH 16	61.8		68.2			12.2				20.1	15.8	83	25		A
RZD 16	61.8		80.5							20.7	16.2	57	18		
RZU 16	61.8		80.5							20.4	16.0	68	18		
RH 20	67.3		79.2			14.2				25.2	19.8	122	33		B
RZD 18	67.3		85.0							23.0	18.0	78	22		
RZU 18	67.3		85.0							22.6	17.8	92	22		

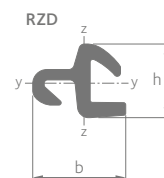
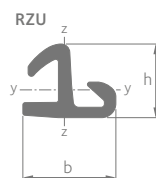
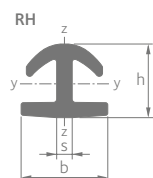

¹⁾ Available upon request.

The outstanding feature of the HZ/AZ combined wall system is the extensive range of possible combinations using the entire AZ sheet pile offer, including the latest wide AZ-800 range, as well as all rolled-up and rolled-down AZ sections. The table below contains but a small sample of the available systems. **Please refer to our brochure "The HZ®-M Steel Wall System" for detailed information on the entire HZ®/AZ® range.**

Denomination example of the HZ/AZ system:

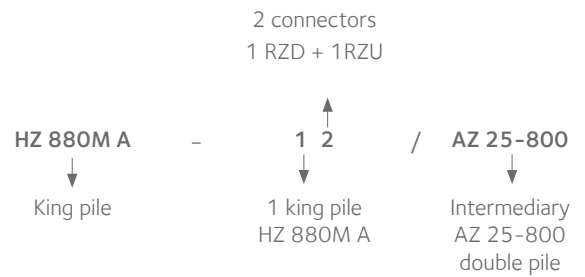

Taipei Port, Taiwan



CT, JadeWeserPort, Germany



	Section	Sectional area cm ² /m	Moment of inertia cm ⁴ /m	Elastic ¹⁾ section modulus cm ³ /m	Elastic ²⁾ section modulus cm ³ /m	Mass ³⁾		Coating area ⁴⁾ Water side m ² /m	
						Mass ₁₀₀ kg/m ²	Mass ₆₀ kg/m ²		
<p>$b_{\text{sys}} = 2.127 \text{ m}^{(6)}$</p>	Combination HZ ... M - 12 / AZ 25-800	HZ 630M⁵⁾	292.3	165710	4870	5455	229	184	2.70
		HZ 880M A	279.5	237700	5315	6085	219	175	2.73
		HZ 880M B	294.4	254470	5720	6445	231	187	2.74
		HZ 880M C	301.2	265850	5970	6705	236	192	2.74
		HZ 1080M A	316.0	418410	7315	8205	248	203	2.73
		HZ 1080M B	326.8	449000	7850	8755	257	212	2.73
		HZ 1080M C	346.3	485830	8510	9400	272	227	2.73
		HZ 1080M D	362.1	521780	9120	10045	284	240	2.73
		HZ 1180M A	374.7	548790	9560	10525	294	250	2.73
		HZ 1180M B	382.8	572490	9970	10935	300	256	2.74
		HZ 1180M C	398.4	607290	10505	11575	313	267	2.75
		HZ 1180M D	410.8	634670	11015	12010	322	277	2.75
	<p>$b_{\text{sys}} = 2.598 \text{ m}^{(7)}$</p>	Combination HZ ... M - 24 / AZ 25-800	HZ 630M⁵⁾	377.5	236070	7245	6665	296	259
		HZ 880M A	354.3	351950	8250	7630	278	242	3.26
		HZ 880M B	378.3	378400	8875	8245	297	261	3.26
		HZ 880M C	389.5	396910	9280	8665	306	269	3.26
		HZ 1080M A	414.3	646970	11760	11065	325	289	3.25
		HZ 1080M B	431.8	695900	12610	11935	339	302	3.25
		HZ 1080M C	463.5	755430	13670	13005	364	327	3.26
		HZ 1080M D	489.3	813780	14665	14045	384	348	3.26
		HZ 1180M A	509.8	857500	15370	14825	400	364	3.26
		HZ 1180M B	522.1	893300	15970	15460	410	373	3.26
		HZ 1180M C	549.4	955970	17010	16445	431	394	3.28
		HZ 1180M D	567.7	994160	17650	17125	446	409	3.29

¹⁾ Referring outside of HZ-M flange.

²⁾ Referring outside of RH / RZ.

³⁾ $L_{RH} = L_{HZ}$; $L_{RZU} = L_{RZD} = L_{AZ}$; $Mass_{100}$: $L_{AZ} = 100\% L_{HZ}$; $Mass_{60}$: $L_{AZ} = 60\% L_{HZ}$.

⁴⁾ Excluding inside of interlocks, per system width.

⁵⁾ Available upon request.

⁶⁾ For HZ 630M $b_{\text{sys}} = 2.090 \text{ m}$

⁷⁾ For HZ 630M $b_{\text{sys}} = 2.524 \text{ m}$

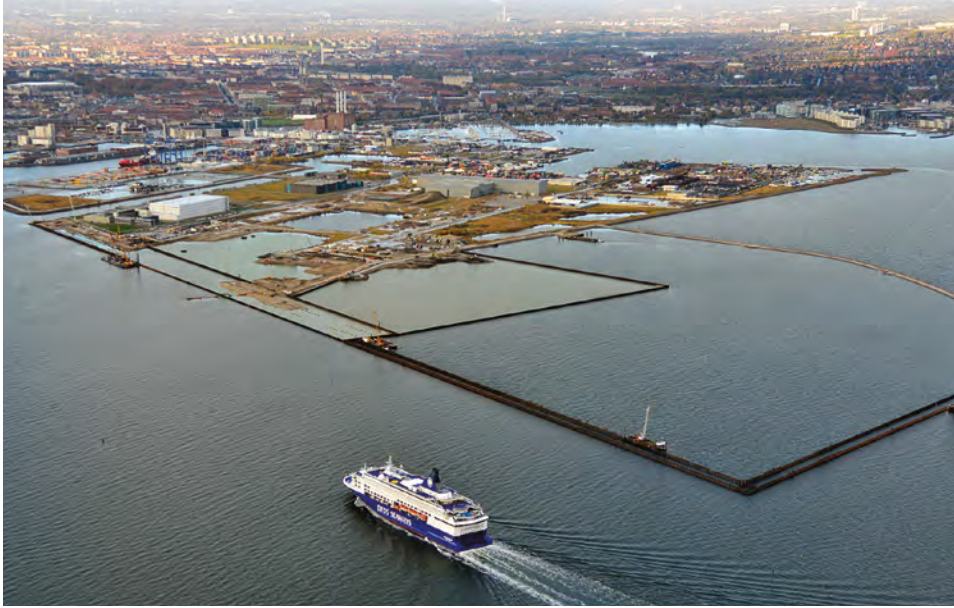

AS 500[®] straight web sections

AS 500 straight web sheet piles are designed to form closed cylindrical structures retaining a soil fill. The stability of the cells consisting of a steel envelope and an internal body of soil is guaranteed by their own weight. Straight web sheet piles are mostly used on projects where rock layers are close to ground level or where anchoring would be difficult or impossible. Straight web sheet pile structures are made of circular cells or diaphragm cells, depending on the site characteristics or the particular requirements of the project. The forces developing in these sheet pile sections are essentially horizontal tensile forces requiring an interlock resistance corresponding to the horizontal force in the web of the pile. AS 500 interlocks comply with EN 10248. **Please refer to our brochure "AS 500[®] Straight web steel sheet piles – design & execution manual" for further details.**

Section	Nominal width ¹⁾ b mm	Web thickness t mm	Deviation angle ²⁾ δ °	Perimeter cm	Sectional area		Mass kg/m	Mass per m ² of wall kg/m ²	Moment of inertia cm ⁴	Section modulus (single pile) cm ³	Coating area ³⁾ m ² /m
					(single pile) cm ²						
AS 500 - 9.5	500	9.5	4.5	138	81.3	63.8	128	168	46	0.58	
AS 500 - 11.0	500	11.0	4.5	139	89.4	70.2	140	186	49	0.58	
AS 500 - 12.0	500	12.0	4.5	139	94.6	74.3	149	196	51	0.58	
AS 500 - 12.5	500	12.5	4.5	139	97.2	76.3	153	201	51	0.58	
AS 500 - 12.7	500	12.7	4.5	139	98.2	77.1	154	204	51	0.58	
AS 500 - 13.0 ⁴⁾	500	13.0	4.5	140	100.6	79.0	158	213	54	0.58	

¹⁾ The effective width to be taken into account for design purposes (layout) is 503 mm for all AS 500 sheet piles.

²⁾ Max. deviation angle 4.0° for pile length > 20 m.

³⁾ One side, excluding inside of interlocks.

⁴⁾ Please contact ArcelorMittal Sheet Piling for further information.

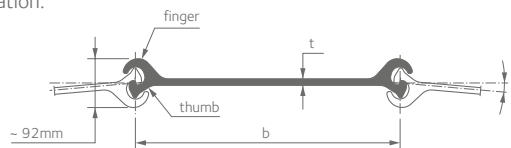

General cargo berth, Bal Haf, Yemen



The following characteristic interlock resistance can be guaranteed:

Section	$R_{k,s}$ [kN/m] ⁵⁾
AS 500 - 9.5	3500
AS 500 - 11.0	4000
AS 500 - 12.0	5000
AS 500 - 12.5	5500
AS 500 - 12.7	5500
AS 500 - 13.0	6000

⁵⁾ For the related steel grade and further information, please contact ArcelorMittal Sheet Piling.

For AS 500 pile verification, both yield resistance of the web and ultimate resistance of the interlock should be checked.

Bridge construction, South Korea



Junction piles and bent piles

Junction piles that join circular cells and intermediary arcs can be provided. Bent piles are pre-bent at the mill. If the deviation angle exceeds 4.5° (4.0° if $L > 20$ m), bent piles can be used to set up structures with small radii.

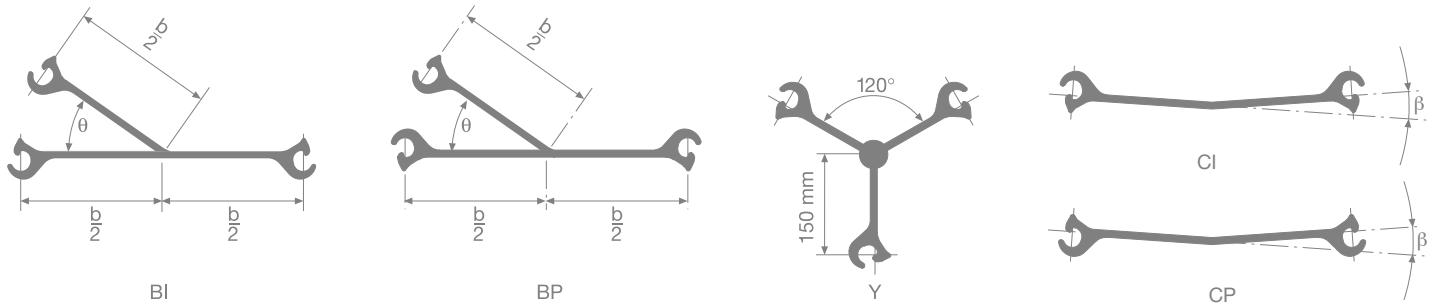

Types of cells

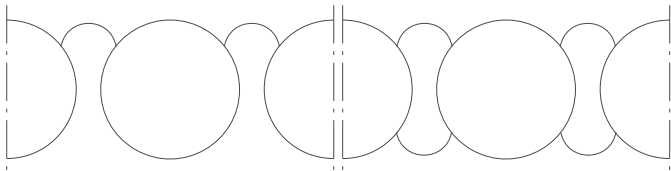

Circular cells with 35° junction piles and one or two connecting arcs.

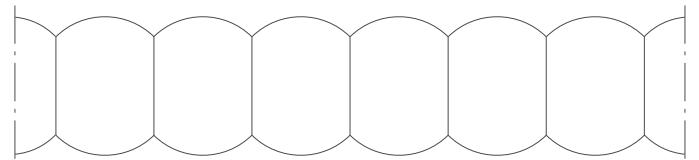

Diaphragm cells with 120° junction piles.

Hissmofors, Sweden



Lock, Arkansas, USA

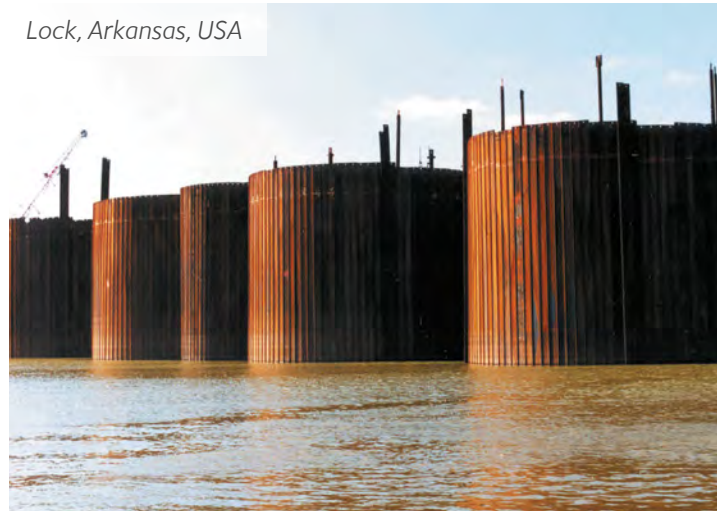

Circular cell construction



1. Installation of template



2. Threading until cell closure



3. Driving

Equivalent width

The equivalent width w_e which is required for stability verification determines the geometry of the chosen cellular construction.

• for circular cells

The equivalent width w_e is defined as:

$$w_e = \frac{\text{Area within 1 cell} + \text{Area within 1 (or 2) arc(s)}}{\text{System length } x}$$

The ratio R_a indicates how economical the chosen circular cell will be.

It is defined as follows

$$R_a = \frac{\text{Development 1 cell} + \text{Development 1 (or 2) arc(s)}}{\text{System length } x}$$

• for diaphragm cells

The equivalent width w_e is defined as:

$$w_e = \text{diaphragm wall length (dl)} + 2 \cdot c$$

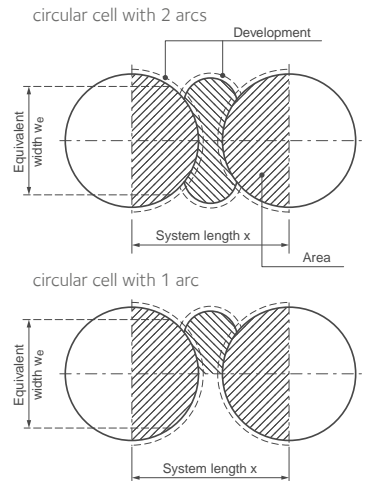
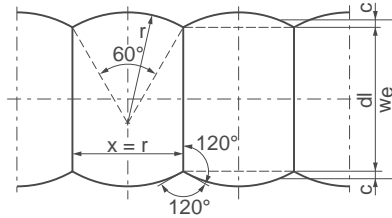

Geometry of circular cells

Once the equivalent width has been determined, the geometry of the cells can be defined. This can be done with the help of tables or with computer programs.

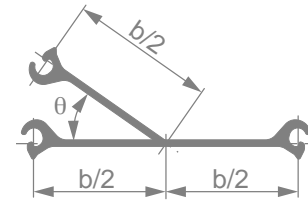
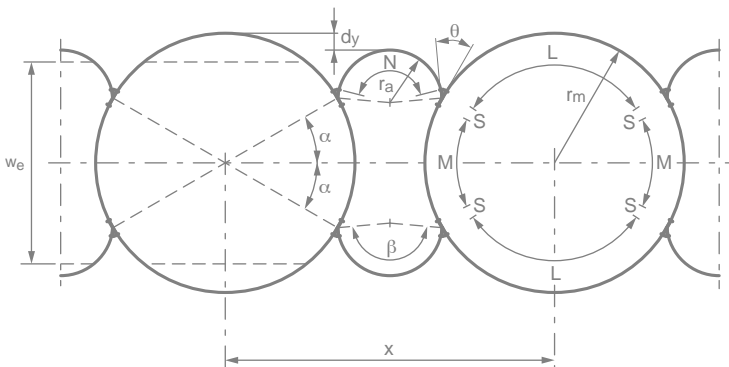

- r_m = radius of the main cell
- r_a = radius of the connecting arcs
- θ = angle between the main cell and the connecting arc
- x = system length
- d_y = positive or negative offset between the connecting arcs and the tangent planes of the main cells
- w_e = equivalent width

Junction piles with angles θ between 30° and 45° , as well as $\theta = 90^\circ$, are available on request.

The table below shows a short selection of circular cells with 2 arcs and standard junction piles with $\theta = 35^\circ$.

	Nb. of piles per					Geometrical values							Interlock deviation		Design values	
	Cell		Arc	System		$d = 2 \cdot r_m$ m	r_a m	x m	d_y m	α °	β °	δ_m °	δ_a °	w_e m	R_a	
Total pcs.	L pcs.	M pcs.	S pcs.	N pcs.	pcs.											Cell
100	33	15	1	25	150	16.01	4.47	22.92	0.16	28.80	167.60	3.60	6.45	13.69	3.34	
104	35	15	1	27	158	16.65	4.88	24.42	0.20	27.69	165.38	3.46	5.91	14.14	3.30	
108	37	15	1	27	162	17.29	4.94	25.23	0.54	26.67	163.33	3.33	5.83	14.41	3.27	
112	37	17	1	27	166	17.93	4.81	25.25	0.33	28.93	167.86	3.21	6.00	15.25	3.35	
116	37	19	1	27	170	18.57	4.69	25.27	0.13	31.03	172.07	3.10	6.15	16.08	3.42	
120	39	19	1	29	178	19.21	5.08	26.77	0.16	30.00	170.00	3.00	5.67	16.54	3.38	
124	41	19	1	29	182	19.85	5.14	27.59	0.50	29.03	168.06	2.90	5.60	16.82	3.35	
128	43	19	1	31	190	20.49	5.55	29.09	0.53	28.13	166.25	2.81	5.20	17.27	3.32	
132	43	21	1	31	194	21.13	5.42	29.11	0.33	30.00	170.00	2.73	5.31	18.10	3.39	
136	45	21	1	33	202	21.77	5.82	30.61	0.36	29.12	168.24	2.65	4.95	18.56	3.35	
140	45	23	1	33	206	22.42	5.71	30.62	0.17	30.86	171.71	2.57	5.05	19.39	3.42	
144	47	23	1	33	210	23.06	5.76	31.45	0.50	30.00	170.00	2.50	5.00	19.67	3.39	
148	47	25	1	35	218	23.70	5.99	32.13	0.00	31.62	173.24	2.43	4.81	20.67	3.44	
152	49	25	1	35	222	24.31	6.05	32.97	0.34	30.79	171.58	2.37	4.77	20.95	3.42	

Geometry of diaphragm cells

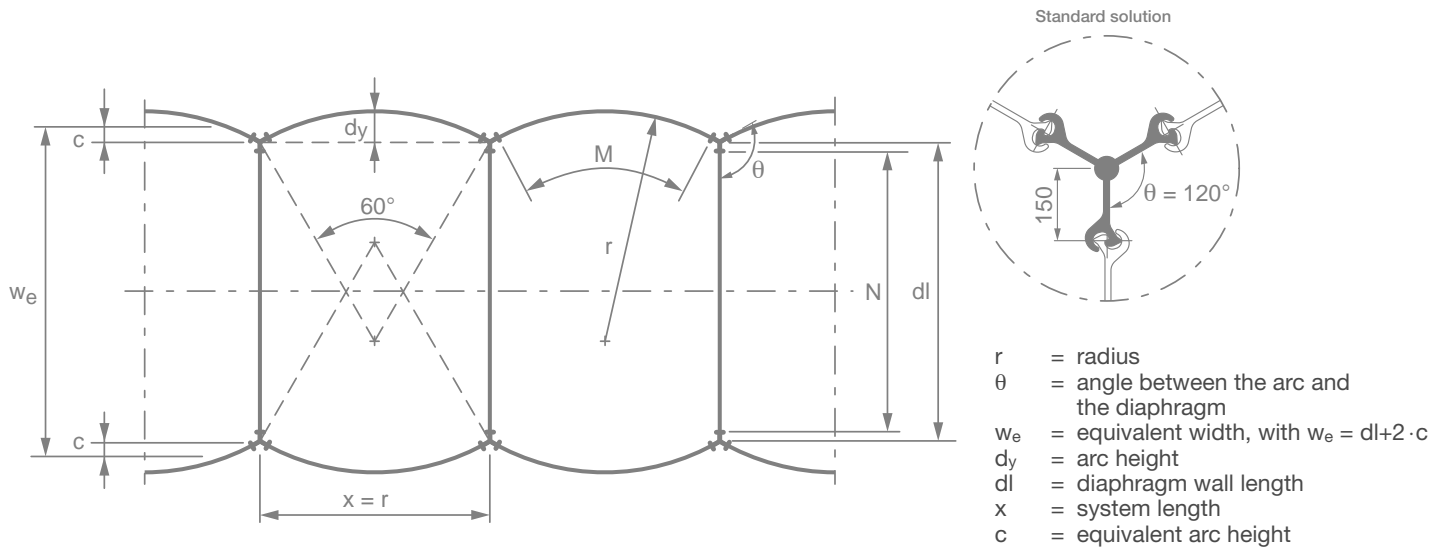

Geometry diaphragm wall

Number of piles	Wall length
N pcs.	dl m
11	5.83
13	6.84
15	7.85
17	8.85
19	9.86
21	10.86
23	11.87
25	12.88
27	13.88
29	14.89
31	15.89
33	16.90
35	17.91
37	18.91
39	19.92
41	20.92
43	21.93
45	22.94
47	23.94
49	24.95
51	25.95
53	26.96
55	27.97
57	28.97
59	29.98

Geometry arc (Standard solution)

Number of piles	Radius System length	Arc height	Equivalent arc height	Interlock deviation
M pcs.	$x = r$ m	d_y m	c m	δ_a
11	5.57	0.75	0.51	5.17
13	6.53	0.87	0.59	4.41
15	7.49	1.00	0.68	3.85
17	8.45	1.13	0.77	3.41
19	9.41	1.26	0.86	3.06
21	10.37	1.39	0.94	2.78
23	11.33	1.52	1.03	2.54
25	12.29	1.65	1.12	2.34
27	13.26	1.78	1.20	2.17
29	14.22	1.90	1.29	2.03
31	15.18	2.03	1.38	1.90
33	16.14	2.16	1.46	1.79
35	17.10	2.29	1.55	1.69
37	18.06	2.42	1.64	1.60
39	19.02	2.55	1.73	1.52
41	19.98	2.68	1.81	1.44
43	20.94	2.81	1.90	1.38

Box piles

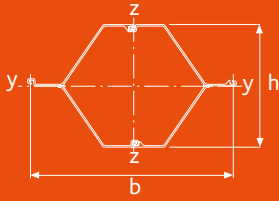

Z-box pile

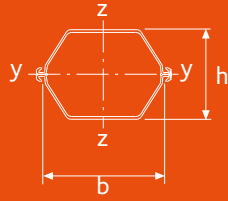

Double U box pile

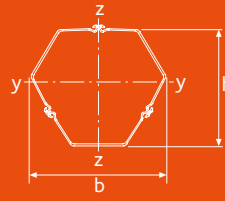

Triple U box pile

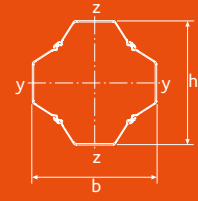

Quadruple U box pile

Section	Width	Height	Perimeter	Sectional area	Total section	Mass ¹⁾	Moment of inertia		Elastic section modulus		Min. radius of gyration	Coating area ²⁾
	b mm	h mm					cm	cm ²	cm ²	kg/m		
CAZ-800 box piles												
CAZ 18-800	1600	898	438	363	7340	285	339470	650340	7535	7915	30.6	4.16
CAZ 20-800	1600	900	438	400	7372	314	372430	713410	8250	8690	30.5	4.16
CAZ 22-800	1600	902	439	436	7404	342	405710	776690	8965	9465	30.5	4.16
CAZ 23-800	1600	948	445	423	7764	332	447370	756450	9405	9170	32.5	4.24
CAZ 25-800	1600	950	446	460	7796	361	484690	820800	10170	9990	32.5	4.24
CAZ 27-800	1600	952	446	497	7829	390	522220	885310	10930	10750	32.4	4.24
CAZ-750 box piles												
CAZ 28-750	1500	1018	445	453	7829	356	547100	702950	10715	9080	34.8	4.23
CAZ 30-750	1500	1020	446	490	7861	385	590180	758880	11535	9840	34.7	4.23
CAZ 32-750	1500	1022	446	527	7892	414	633500	815060	12360	10535	34.7	4.23
CAZ-700 and CAZ-770 box piles												
CAZ 12-770	1540	687	389	328	5431	257	175060	557990	5075	6985	23.1	3.67
CAZ 13-770	1540	688	389	344	5446	270	183440	584640	5310	7320	23.1	3.67
CAZ 14-770	1540	689	390	360	5461	283	191840	611300	5545	7655	23.1	3.67
CAZ 14-770-10/10	1540	690	390	376	5476	295	200280	637960	5780	7995	23.1	3.67
CAZ 12-700	1400	628	360	303	4524	238	137770	421600	4365	5785	21.3	3.39
CAZ 13-700	1400	630	361	332	4552	261	150890	461210	4765	6335	21.3	3.39
CAZ 13-700-10/10	1400	631	361	347	4565	272	157530	481090	4965	6610	21.3	3.39
CAZ 14-700	1400	632	361	362	4579	284	164130	500820	5165	6885	21.3	3.39
CAZ 17-700	1400	839	391	330	6015	259	265280	457950	6300	6285	28.3	3.69
CAZ 18-700	1400	840	391	347	6029	272	277840	479790	6590	6590	28.3	3.69
CAZ 20-700	1400	842	392	379	6058	297	303090	523460	7170	7195	28.3	3.69
CAZ 24-700	1400	918	407	436	6616	342	412960	596900	8965	8260	30.8	3.85
CAZ 26-700	1400	920	407	469	6645	368	444300	641850	9625	8900	30.8	3.85
CAZ 28-700	1400	922	408	503	6674	395	475810	686880	10285	9510	30.8	3.85

¹⁾ The mass of the welds is not taken into account.

²⁾ Outside surface, excluding inside of interlocks.

Section	Width	Height	Perimeter	Sectional area	Total section	Mass ¹⁾	Moment of inertia		Elastic section modulus		Min. radius of gyration	Coating area ²⁾
	b mm	h mm					y-y cm ⁴	z-z cm ⁴	y-y cm ³	z-z cm ³		

CAZ-700 and CAZ-770 box piles

CAZ 36-700N	1400	998	434	534	7215	419	627000	710770	12525	9895	34.3	4.12
CAZ 38-700N	1400	1000	435	570	7245	447	667900	757530	13315	10550	34.2	4.12
CAZ 40-700N	1400	1002	436	606	7275	476	709010	804300	14105	11205	34.2	4.12
CAZ 42-700N	1400	998	433	646	7267	507	744440	855860	14870	11915	34.0	4.11
CAZ 44-700N	1400	1000	434	682	7298	535	785620	902800	15660	12570	33.9	4.11
CAZ 46-700N	1400	1002	434	718	7328	564	827030	949760	16455	13225	33.9	4.11
CAZ 48-700	1400	1006	435	710	7346	558	845530	931330	16745	12965	34.5	4.13
CAZ 50-700	1400	1008	435	746	7376	586	887420	977550	17540	13620	34.5	4.13
CAZ 52-700	1400	1010	436	782	7406	614	929550	1023800	18335	14255	34.5	4.13

CAZ box piles

CAZ 18	1260	760	361	333	4925	261	222930	365500	5840	5560	25.9	3.41
CAZ 26	1260	854	377	440	5566	346	366820	480410	8555	7385	28.9	3.57

- ¹⁾ The mass of the welds is not taken into account.
²⁾ Outside surface, excluding inside of interlocks.

Wroclaw flood protection system, Poland

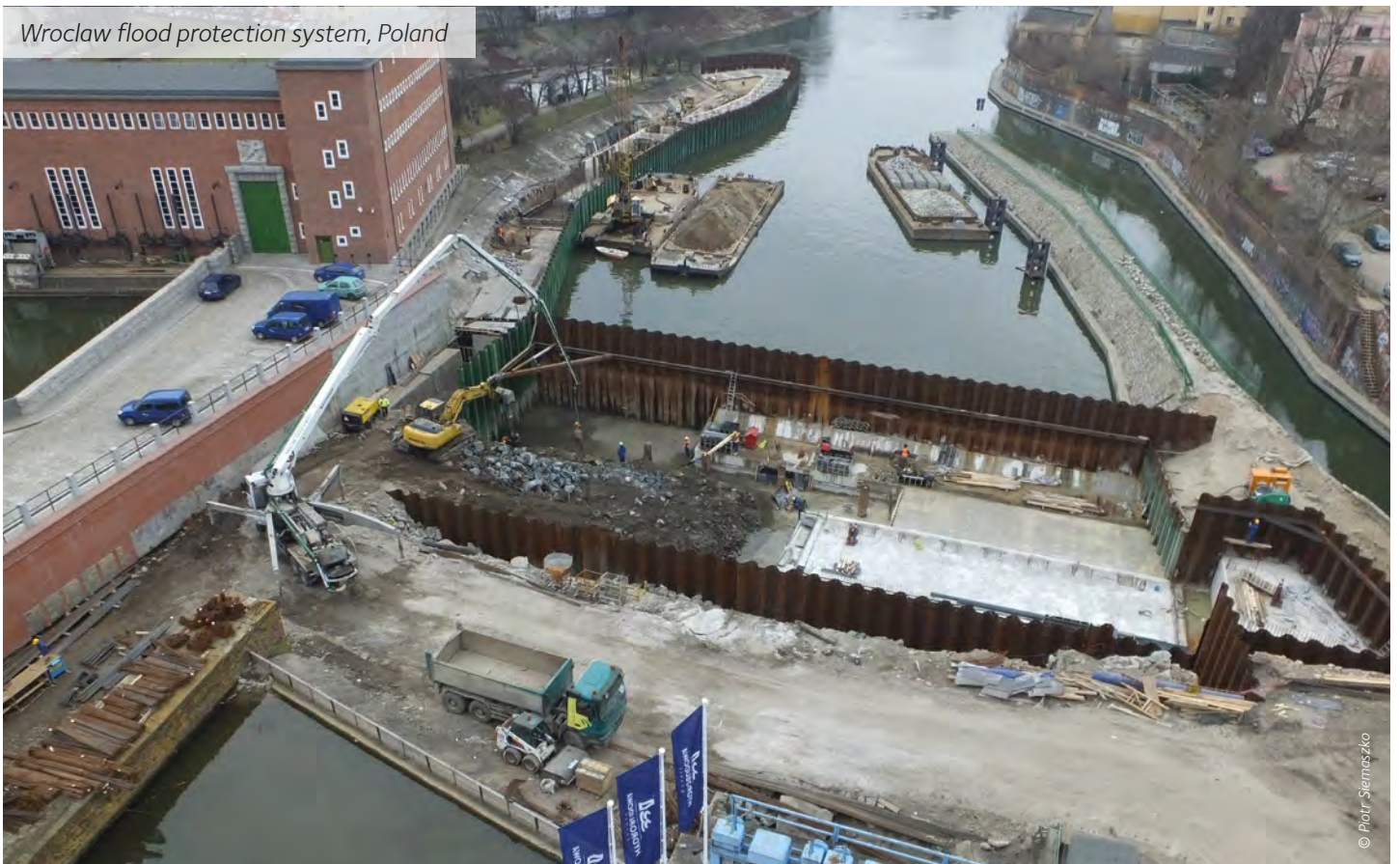

Section	Width	Height	Perimeter	Sectional area	Total section	Mass ¹⁾	Moment of inertia		Elastic section modulus		Min. radius of gyration	Coating area ²⁾
	b mm	h mm					cm	cm ²	cm ²	kg/m		
CAU double box piles												
CAU 14-2	750	451	230	198	2598	155.8	54400	121490	2415	3095	16.6	2.04
CAU 16-2	750	454	231	220	2620	172.5	62240	130380	2745	3325	16.8	2.04
CAU 18-2	750	486	239	225	2888	177.0	73770	142380	3035	3625	18.1	2.14
CAU 20-2	750	489	240	247	2910	193.8	83370	151220	3405	3850	18.4	2.14
CAU 23-2	750	492	244	260	3013	204.2	94540	157900	3845	4020	19.1	2.19
CAU 25-2	750	495	245	281	3034	220.8	104810	166600	4235	4240	19.3	2.19
CU double box piles												
CU 12-2	600	403	198	168	1850	132.2	34000	70000	1685	2205	14.2	1.72
CU 12S-2	600	405	198	181	1867	142.1	36120	76410	1785	2410	14.1	1.72
CU 18-2	600	473	212	196	2184	153.8	58020	78300	2455	2470	17.2	1.86
CU 22-2	600	494	220	219	2347	172.3	73740	88960	2985	2800	18.3	1.94
CU 28-2	600	499	226	259	2468	203.6	96000	103560	3850	3260	19.2	2.00
CU 32-2	600	499	223	291	2461	228.3	108800	109200	4360	3435	19.3	1.97
CGU double box piles												
CGU 7N-2	600	348	187	112	1596	88.2	16510	48530	950	1535	12.1	1.62
CGU 7S-2	600	349	188	118	1604	92.5	18210	50630	1045	1605	12.3	1.62
CGU 11N-2	600	359	193	153	1707	120.4	27670	60590	1540	1915	13.4	1.67
CGU 14N-2	600	461	205	164	2079	128.6	44070	65550	1910	2075	16.4	1.79
CGU 18N-2	600	473	212	196	2184	153.8	58020	78300	2455	2470	17.2	1.86
CGU 22N-2	600	494	220	219	2347	172.3	73740	88960	2985	2800	18.3	1.94
CGU 28N-2	600	499	226	259	2468	203.6	96000	103560	3850	3260	19.2	2.00
CGU 32N-2	600	499	223	291	2461	228.3	108800	109200	4360	3435	19.3	1.97
CGU 16-400	400	336	169	158	1170	123.9	25270	31900	1505	1465	12.7	1.40

¹⁾ The mass of the welds is not taken into account.

²⁾ Outside surface, excluding inside of interlocks.

Section	Width	Height	Perimeter	Sectional area	Total section	Mass ¹⁾	Moment of inertia		Elastic section modulus		Min. radius of gyration	Coating area ²⁾
	b mm	h mm					cm	cm ²	cm ²	kg/m		
CAU triple box piles												
CAU 14-3	957	908	341	298	6454	233.7	300330		6510	6275	31.7	3.03
CAU 16-3	960	910	342	330	6486	258.7	333640		7235	6955	31.8	3.03
CAU 18-3	1009	927	355	338	6886	265.5	363690		7825	7205	32.8	3.17
CAU 20-3	1012	928	356	370	6919	290.7	399780		8570	7900	32.9	3.17
CAU 23-3	1036	930	361	390	7073	306.3	431940		9235	8340	33.3	3.24
CAU 25-3	1038	931	364	422	7106	331.3	469030		9995	9035	33.3	3.24
CU triple box piles												
CU 12-3	800	755	293	253	4431	198.3	173100		4555	4325	26.2	2.54
CU 12S-3	802	756	294	271	4457	213.1	186260		4890	4645	26.2	2.54
CU 18-3	877	790	315	294	4931	230.7	227330		5475	5185	27.8	2.76
CU 22-3	912	801	326	329	5174	258.4	268440		6310	5890	28.6	2.87
CU 28-3	938	817	336	389	5356	305.4	330290		7720	7040	29.1	2.96
CU 32-3	926	809	331	436	5345	342.4	367400		8585	7935	29.0	2.92
CGU triple box piles												
CGU 11N-3	781	730	285	230	4206	180.7	150670		4040	3860	25.6	2.47
CGU 14N-3	844	781	305	246	4763	192.8	182730		4475	4330	27.3	2.65
CGU 18N-3	877	790	315	294	4931	230.7	227330		5475	5185	27.8	2.76
CGU 22N-3	912	801	326	329	5174	258.4	268440		6310	5890	28.6	2.87
CGU 28N-3	938	817	336	389	5356	305.4	330290		7720	7040	29.1	2.96
CGU 32N-3	926	809	331	436	5345	342.4	367400		8585	7935	29.0	2.92

¹⁾ The mass of the welds is not taken into account.

²⁾ Outside surface, excluding inside of interlocks.

Vilanova, Barcelona, Spain



Section	Width	Height	Perimeter	Sectional area	Total section	Mass ¹⁾	Moment of inertia		Elastic section modulus		Min. radius of gyration	Coating area ²⁾
	b mm	h mm					y-y cm ⁴	z-z cm ⁴	y-y cm ³	z-z cm ³		

CAU quadruple box piles

CAU 14-4	1222	1222	453	397	11150	311.6	692030	11325	41.7	4.02
CAU 16-4	1225	1225	454	440	11193	345.0	770370	12575	41.8	4.02
CAU 18-4	1258	1258	471	451	11728	354.0	826550	13140	42.8	4.20
CAU 20-4	1261	1261	472	494	11771	387.6	910010	14430	42.9	4.20
CAU 23-4	1263	1263	481	520	11977	408.4	979870	15510	43.4	4.30
CAU 25-4	1266	1266	482	563	12020	441.6	1064910	16820	43.5	4.30

CU quadruple box piles

CU 12-4	1025	1025	388	337	7565	264.4	394000	7690	34.2	3.36
CU 12S-4	1027	1027	389	362	7598	284.1	423410	8250	34.2	3.36
CU 18-4	1095	1095	417	392	8231	307.6	507240	9270	36.0	3.65
CU 22-4	1115	1115	432	439	8556	344.6	593030	10635	36.8	3.80
CU 28-4	1120	1120	445	519	8799	407.2	725730	12955	37.4	3.93
CU 32-4	1120	1120	440	582	8782	456.6	811100	14480	37.3	3.87

CGU quadruple box piles

CGU 11N-4	979	979	379	307	7254	240.9	347050	7095	33.6	3.27
CGU 14N-4	1081	1081	404	328	7997	257.1	409870	7585	35.4	3.51
CGU 18N-4	1095	1095	417	392	8231	307.6	507240	9270	36.0	3.65
CGU 22N-4	1115	1115	432	439	8556	344.6	593030	10635	36.8	3.80
CGU 28N-4	1120	1120	445	519	8799	407.2	725730	12955	37.4	3.93
CGU 32N-4	1120	1120	440	582	8782	456.6	811100	14480	37.3	3.87

¹⁾ The mass of the welds is not taken into account.

²⁾ Outside surface, excluding inside of interlocks.

Changxin dry dock, Shanghai, China

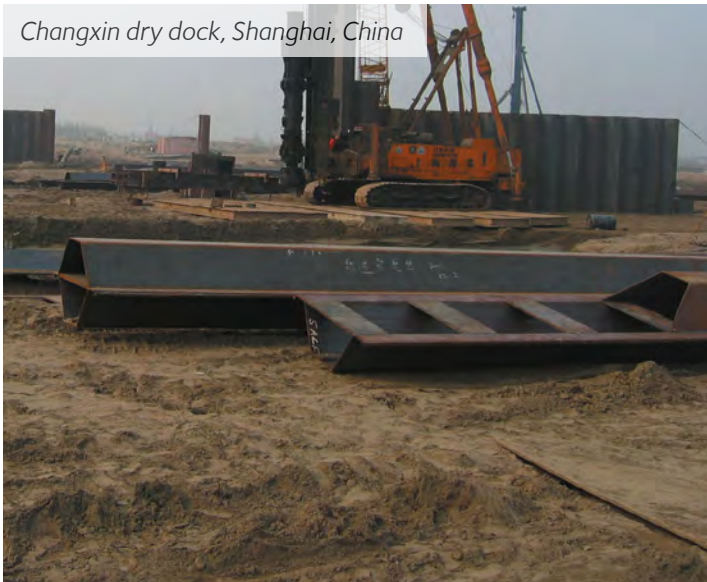

Vilanova, Barcelona, Spain



Jagged wall

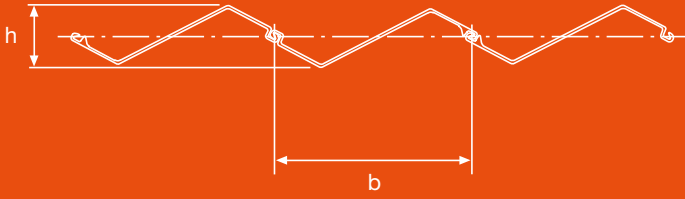

AZ® jagged wall: AZ® sections threaded in reverse may form arrangements for special applications. The jagged wall arrangement represents a very economical solution for sealing screens (reduced height, reliable thickness, low driving resistance).

AZ® jagged wall

Section	Width b mm	Height h mm	Sectional area cm ² /m	Mass kg/m ²	Moment of inertia cm ⁴ /m	Elastic section modulus cm ³ /m	Coating area ¹⁾ m ² /m ²
AZ-800							
AZ 18-800	897	242	115	90	4780	395	1.16
AZ 20-800	897	243	126	99	5340	440	1.16
AZ 22-800	897	244	137	107	5900	485	1.16
AZ 23-800	907	255	133	104	6070	475	1.17
AZ 25-800	907	257	144	113	6670	520	1.17
AZ 27-800	907	258	155	122	7260	565	1.17
AZ-750							
AZ 28-750	881	278	146	114	7970	575	1.20
AZ 30-750	881	280	157	123	8690	620	1.20
AZ 32-750	881	281	169	132	9420	670	1.20
AZ-700 and AZ-770							
AZ 12-770	826	181	112	88	2320	255	1.12
AZ 13-770	826	182	117	92	2450	270	1.12
AZ 14-770	826	182	123	96	2590	285	1.12
AZ 14-770-10/10	826	183	128	100	2720	295	1.12
AZ 12-700	751	182	115	90	2400	265	1.13
AZ 13-700	751	183	126	99	2680	295	1.13
AZ 13-700-10/10	751	183	131	103	2820	305	1.13
AZ 14-700	751	184	136	107	2960	320	1.13
AZ 17-700	795	224	117	92	3690	330	1.16
AZ 18-700	795	224	123	96	3910	350	1.16
AZ 19-700	795	225	128	101	4120	365	1.16
AZ 20-700	795	225	134	105	4340	385	1.16
AZ 24-700	813	241	150	118	5970	495	1.19
AZ 26-700	813	242	161	127	6490	535	1.19
AZ 28-700	813	243	172	135	7020	580	1.19

¹⁾ One side, excluding inside of interlocks.

AZ® jagged wall

Section	Width	Height	Sectional area	Mass	Moment of inertia	Elastic section modulus	Coating area ¹⁾
	b mm	h mm	cm ² /m	kg/m ²	cm ⁴ /m	cm ³ /m	m ² /m ²
AZ-700 and AZ-770							
AZ 36-700N	834	296	181	142	11900	805	1.23
AZ 38-700N	834	298	193	152	12710	855	1.23
AZ 40-700N	834	299	205	161	13530	905	1.23
AZ 42-700N	834	301	217	170	14730	975	1.24
AZ 44-700N	834	303	229	180	15550	1025	1.24
AZ 46-700N	834	304	241	189	16370	1075	1.24
AZ 48-700	836	303	242	190	16290	1075	1.23
AZ 50-700	836	303	253	199	17100	1130	1.23
AZ 52-700	836	305	265	208	17900	1175	1.23

AZ

AZ 18	714	225	133	104	4280	380	1.19
AZ 18-10/10	714	225	139	109	4500	400	1.19
AZ 26	736	238	169	133	6590	555	1.21

¹⁾ One side, excluding inside of interlocks.

Temporary trench, Brenner railway, Austria



U jagged wall

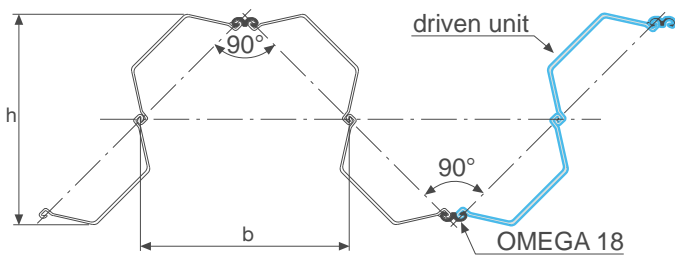

An arrangement of U-sheet piles forming a jagged wall offers economical solutions where high inertia and section modulus are needed. The final choice of section has to include drivability criteria. The mechanical values given below assume that the driven unit is crimped or welded. The OMEGA 18 section is normally threaded and welded at the mill, either by tack weld (no contribution to the

section modulus of the jagged wall) or by an appropriately designed weld (full contribution to the section modulus). For walls with an anchorage or strut system, stiffeners have to be provided at the support levels.



Section	Width b mm	Height h mm	Mass kg/m ²	Moment of inertia ¹⁾		Elastic section modulus ¹⁾		Static moment	
				without Omega 18 cm ⁴ /m	with Omega 18 cm ⁴ /m	without Omega 18 cm ³ /m	with Omega 18 cm ³ /m	without Omega 18 cm ³ /m	with Omega 18 cm ³ /m

AU™ jagged wall

AU 14	1135	1115	153	275920	334450	5080	5995	3080	3625
AU 16	1135	1115	168	307090	365630	5650	6555	3435	3980
AU 18	1135	1136	172	329420	387960	5800	6830	3595	4135
AU 20	1135	1139	187	362620	421160	6370	7400	3960	4505
AU 23	1135	1171	196	390770	449300	6675	7675	4235	4780
AU 25	1135	1173	210	424630	483170	7240	8240	4610	5150

PU® jagged wall

PU 12	923	903	163	188980	235400	4275	5210	2590	3125
PU 12S	923	903	174	202370	248810	4570	5510	2770	3305
PU 18	923	955	186	244470	290890	5120	6095	3215	3755
PU 22	923	993	206	286030	332460	5760	6695	3690	4230
PU 28	923	1027	240	349890	396310	6810	7715	4465	5000
PU 32	923	1011	267	389310	435740	7705	8625	5015	5550

GU® jagged wall

GU 11N	923	903	150	167340	213770	3790	4735	2335	2875
GU 14N	923	920	159	198710	245140	4320	5330	2645	3180
GU 18N	923	955	186	244470	290890	5120	6095	3215	3755
GU 22N	923	993	206	286030	332460	5760	6695	3690	4230
GU 28N	923	1027	240	349890	396310	6810	7715	4465	5000
GU 32N	923	1011	267	389310	435740	7705	8625	5015	5550

¹⁾ The moment of inertia and elastic section moduli assume correct shear force transfer across the interlock on the neutral axis.

Combined walls

Steel sheet piles can easily be combined to form special arrangements and create systems with large bending resistance:

- box piles / sheet piles;
- HZ[®]-M king piles / sheet piles;
- tubular king piles / sheet piles.

The primary piles or "king piles" of combined walls can also be used as bearing piles submitted to high vertical loads, e.g. crane loads. The intermediary sheet piles act mainly as soil-retaining and load-transferring elements.

Equivalent elastic section modulus

The equivalent elastic section modulus W_{sys} per linear metre of combined wall is based on the assumption that the deflections of king piles and intermediary steel sheet piles are the same, leading to the following formulas:

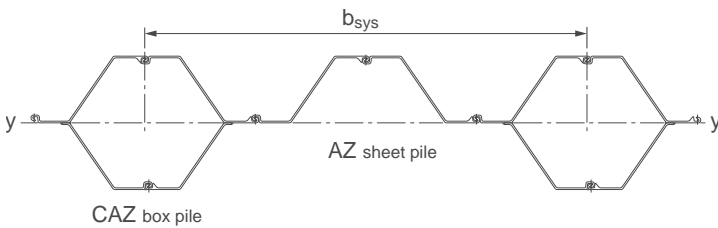

$$I_{sys} = \frac{I_{king\ pile} + I_{ssp}}{b_{sys}}$$

$$W_{sys} = \frac{W_{king\ pile}}{b_{sys}} \cdot \left(\frac{I_{king\ pile} + I_{ssp}}{I_{king\ pile}} \right)$$

I_{sys}	[cm ⁴ /m]:	Moment of inertia of combined wall
W_{sys}	[cm ³ /m]:	Elastic section modulus of combined wall
$I_{king\ pile}$	[cm ⁴]:	Moment of inertia of king pile
I_{ssp}	[cm ⁴]:	Moment of inertia of intermediary sheet pile
$W_{king\ pile}$	[cm ³]:	Elastic section modulus of king pile
b_{sys}	[m]:	System width

CAZ box piles – AZ[®] sheet piles

Combination	System width b_{sys} mm	Mass ₁₀₀ ¹⁾ kg/m ²	Mass ₆₀ ¹⁾ kg/m ²	Moment of inertia I_{sys} cm ⁴ /m	Elastic section modulus W_{sys} cm ³ /m
AZ-800					
CAZ 20-800 / AZ 13-770	3140	148	129	129580	2870
CAZ 20-800 / AZ 18-700	3000	156	135	141780	3140
CAZ 20-800 / AZ 20-800	3200	153	131	138910	3075
CAZ 25-800 / AZ 13-770	3140	163	144	165330	3470
CAZ 25-800 / AZ 18-700	3000	171	151	179200	3760
CAZ 25-800 / AZ 20-800	3200	168	146	173990	3650
AZ-750					
CAZ 30-750 / AZ 13-770	3040	177	157	205470	4015
CAZ 30-750 / AZ 18-700	2900	185	164	221760	4335
CAZ 30-750 / AZ 20-800	3100	181	158	213630	4175
AZ-700 and AZ-770					
CAZ 13-770 / AZ 13-770	3080	137	117	70740	2045
CAZ 13-700 / AZ 13-700	2800	146	125	64160	2025
CAZ 18-700 / AZ 13-770	2940	144	124	106220	2520
CAZ 18-700 / AZ 13-700	2800	150	129	109500	2595
CAZ 18-700 / AZ 18-700	2800	152	130	118130	2800

¹⁾ Mass₁₀₀: $L_{AZ} = 100\% L_{box\ pile}$; Mass₆₀: $L_{AZ} = 60\% L_{box\ pile}$.

CAZ box piles – AZ® sheet piles

Combination	System width b_{sys} mm	Mass ₁₀₀ ¹⁾ kg/m ²	Mass ₆₀ ¹⁾ kg/m ²	Moment of inertia I_{sys} cm ⁴ /m	Elastic section modulus W_{sys} cm ³ /m
AZ-700 and AZ-770					
CAZ 26-700 / AZ 13-770	2940	177	156	162840	3530
CAZ 26-700 / AZ 13-700	2800	185	163	168950	3660
CAZ 26-700 / AZ 18-700	2800	186	164	177580	3845
CAZ 38-700N / AZ 13-770	2940	204	183	238890	4760
CAZ 38-700N / AZ 13-700	2800	213	192	248800	4960
CAZ 38-700N / AZ 18-700	2800	214	193	257440	5130
CAZ 44-700N / AZ 13-770	2940	234	213	278930	5560
CAZ 44-700N / AZ 13-700	2800	244	223	290850	5800
CAZ 44-700N / AZ 18-700	2800	246	224	299480	5970
CAZ 50-700 / AZ 13-770	2940	251	230	313560	6200
CAZ 50-700 / AZ 18-700	2800	264	242	335840	6640
CAZ 50-700 / AZ 20-800	3000	254	231	319830	6320
AZ					
CAZ 18 / AZ 18	2520	163	139	105560	2765
CAZ 26 / AZ 18	2520	196	173	162660	3795

¹⁾ Mass₁₀₀: $L_{AZ} = 100\% L_{box}$ pile; Mass₆₀: $L_{AZ} = 60\% L_{box}$ pile.

Underground car park, Aalst, Belgium



U box piles – U sheet piles

Type of reinforcement:

- Heightwise: full or partial height;
- Lengthwise: total length 1/1 or partial length 1/2, 1/3, 1/4.

Please contact our Technical Department for other combinations (e.g. 2/4).

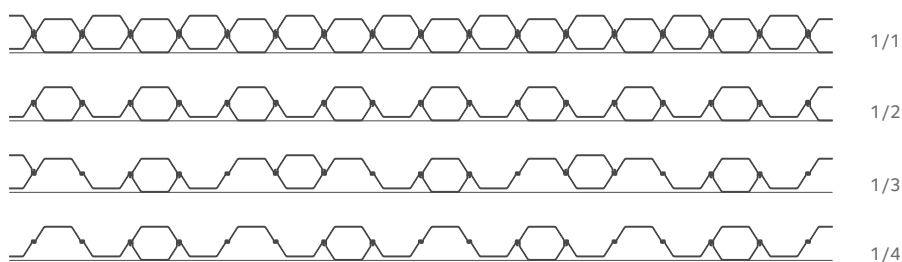

Section	1 / 1			1 / 2			1 / 3			1 / 4		
	Mass kg/m ²	Moment of inertia cm ⁴ /m	Elastic section modulus cm ³ /m	Mass kg/m ²	Moment of inertia cm ⁴ /m	Elastic section modulus cm ³ /m	Mass kg/m ²	Moment of inertia cm ⁴ /m	Elastic section modulus cm ³ /m	Mass kg/m ²	Moment of inertia cm ⁴ /m	Elastic section modulus cm ³ /m

CAU box piles / AU™ sheet piles

AU 14	208	72530	3220	156	40660	1805	139	43300	1920	130	37980	1550
AU 16	230	82990	3660	173	46230	2035	153	49560	2185	144	43440	1755
AU 18	236	98360	4045	177	55020	2260	157	58990	2425	148	51760	1950
AU 20	258	111160	4545	194	61830	2525	172	66680	2725	162	58460	2180
AU 23	272	126050	5125	204	69580	2830	182	75820	3080	170	66410	2435
AU 25	294	139750	5645	221	76800	3105	196	84080	3395	184	73590	2675

CU box piles / PU® sheet piles

PU 12	220	56670	2810	165	32080	1590	147	33290	1650	138	29190	1370
PU 12S	237	60200	2975	178	34120	1685	158	35170	1735	148	30830	1450
PU 18	256	96700	4090	192	54370	2300	171	58000	2450	160	50940	1980
PU 22	287	122900	4975	215	68730	2785	192	73940	2995	180	64920	2395
PU 28	339	160000	6415	255	88390	3545	226	96310	3860	212	84370	3050
PU 32	381	181330	7270	285	99790	4000	254	108660	4355	238	95070	3445

CGU box piles / GU® sheet piles

GU 7N	147	27520	1585	110	15630	900	98	16140	930	92	14160	775
GU 7S	154	30350	1740	116	17150	985	103	17810	1020	96	15610	845
GU 11N	201	46120	2570	151	25790	1435	134	27000	1505	125	23610	1235
GU 14N	214	73440	3185	161	41520	1800	143	44090	1915	134	38760	1550
GU 18N	256	96700	4090	192	54370	2300	171	58000	2450	160	50940	1980
GU 22N	287	122900	4975	215	68730	2785	192	73940	2995	180	64920	2395
GU 28N	339	160000	6415	255	88390	3545	226	96310	3860	212	84370	3050
GU 32N	381	181330	7270	285	99790	4000	254	108660	4355	238	95070	3445
GU 16-400	310	63180	3760	232	35270	2100	207	36110	2150	194	31460	1805

Steel tubes for foundations

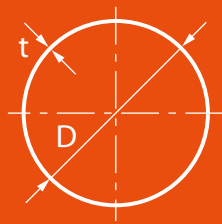

ArcelorMittal manufactures spirally welded tubular foundation piles in its mill located in Dintelmond, The Netherlands, with diameters up to 3000 mm, wall thicknesses up to 25 mm, and lengths up to 53 m (without butt-welding). The mill is located on the waterfront and owns a deep-water quay wall.

Tubular piles are available in numerous European and US steel grades thanks to ArcelorMittal's worldwide network of coil producers. Tubes can be coated on the premises on request. The table below gives an overview of steel tubes used in foundations (bearing piles, combined walls, etc). Other dimensions available upon request.

Steel tubes can also be provided with C9 connectors welded on the tube to form combined wall systems¹⁾. Tubular piles are the main retaining elements of the combined wall, carrying horizontal loads from soil and water pressures, and vertical loads from the anchors and superstructure. The intermediary sheet piles (preferably

AZ sheet piles) transfer horizontal loads to the tubular piles. Please refer to our brochure "**AZ® sheet piles in combined walls**" for more information on the infill sheet piles.

Please refer to our brochure "**Spirally welded steel pipes**" for further details on steel tubes.

Diameter	Thickness	Moment of inertia	Elastic section modulus	Sectional area	Mass
D	t	I	W	A	G
mm	mm	cm ⁴	cm ³	cm ²	kg/m
864	10.0	244620	5665	268.3	210.6
864	12.0	291510	6750	321.2	252.1
864	14.0	337720	7820	373.8	293.5
914	10.0	290150	6350	284.0	222.9
914	12.0	345890	7570	340.0	266.9
914	14.0	400890	8770	395.8	310.7
1016	12.0	476980	9390	378.5	297.1
1016	14.0	553190	10890	440.7	346.0
1016	16.0	628480	12370	502.7	394.6
1219	14.0	962070	15785	530.0	416.0
1219	16.0	1094090	17950	604.7	474.7
1219	18.0	1224780	20095	679.1	533.1
1422	16.0	1746590	24565	706.7	554.8
1422	18.0	1956610	27520	793.9	623.2
1422	20.0	2164820	30450	880.9	691.5
1524	16.0	2154930	28280	758.0	595.0
1524	18.0	2414730	31690	851.6	668.5
1524	20.0	2672450	35070	945.0	741.8
1626	18.0	2939310	36155	909.3	713.8
1626	20.0	3253820	40020	1009.1	792.1
1626	22.0	3565970	43860	1108.6	870.3
1829	18.0	4198850	45915	1024.1	803.9
1829	20.0	4650060	50850	1136.6	892.3
1829	22.0	5098250	55750	1248.9	980.4
2032	20.0	6397590	62970	1264.2	992.4
2032	22.0	7016540	69060	1389.2	1090.5
2032	24.0	7631750	75115	1514.0	1188.5
2540	21.0	13182380	103800	1661.9	1304.6
2540	23.0	14403690	113415	1818.7	1427.7
2540	25.0	15619130	122985	1975.3	1550.6
2997	21.0	21737000	145060	1963.4	1541.2
2997	23.0	23759460	158555	2148.9	1686.9
2997	25.0	25773720	171995	2334.2	1832.3

¹⁾ Disclaimer: ArcelorMittal Sheet Piling highly recommends that Z or U sections used in tube combined walls as infill sheet piles are threaded with C9 connectors. Infill sheet piles threaded to C9 connectors are a proven solution with respect to optimum interlock fitting. In the event of use of a connector other than the C9, ArcelorMittal Commercial RPS S.à r.l. cannot be held liable for any related failure during construction such as and not limited to, increased friction during driving or declutching.

Driving caps

A driving cap is a very important accessory, providing efficient energy transfer between the hammer and the sheet pile section, thus preventing damage to the pile. Impact hammers need special driving caps. Driving caps for diesel hammers are generally made of cast steel, with an arrangement of guiding grooves for the different sheet pile sections on its lower side. A dolly is fitted into a recess on the top of the driving cap. Dollies are normally made of wooden or plastic components or a combination of several different elements. Each driving cap fits for several sheet pile sections, thus the number of required driving caps for a given sheet pile range is reduced.

Driving cap dimensions

Driving caps	A	B	H	C	D	Mass	Dimensions of dolly recess	Corresponding sliding guide
	mm	mm	mm	mm	mm	kg	a/b/h or \varnothing /h	
AUS 14-26	740	580	370	350	305	650	500/300/120	500/90
AUD 12-16	1540	750	520	430	385	1900	600/400/170	700/90
AUD 20-32	1570	750	520	430	385	2100	600/400/170	700/90
PUS	680	600	320	290	265	300	380/380/120	330/50
US-B	680	600	320	290	265	300	380/380/120	330/50
UD 1	1250	610	420	260	350	1000	\varnothing 400/170	30
UD 2	1250	720	420	315	405	1250	\varnothing 500/170	30
PUD 17-33	1250	720	420	315	405	1250	\varnothing 500/170	30
A 18/26	1160	660	420	390	345	1150	600/400/170	500/90
AZD 12-14	1300	590	520	360	315	1700	600/300/170	700/90
AZD 12-14 L	1440	590	520	360	315	1750	600/300/170	700/90
UZD 14-28	1300	705	520	420	375	1900	600/400/170	700/90
AZD 36-40	1320	750	520	440	395	2050	600/400/170	700/90
ZD 800 A	1500	955	420	495	450	2450	\varnothing 600/170	700/90
ZD 800 B	1360	1065	540	560	515	3000	\varnothing 600/170	700/90
ZD 800 A-weld ¹⁾	1510	702	400	420	375	1500	600/400/120	500/90
ZD 800 B-weld ¹⁾	1400	738	430	438	393	1650	600/400/120	500/90
HS 8 - 11	720	1270	430	710	665	1250	\varnothing 600/170	500/90
HD 6 - 11	840	1410	470	770	725	2350	\varnothing 600/170	700/90

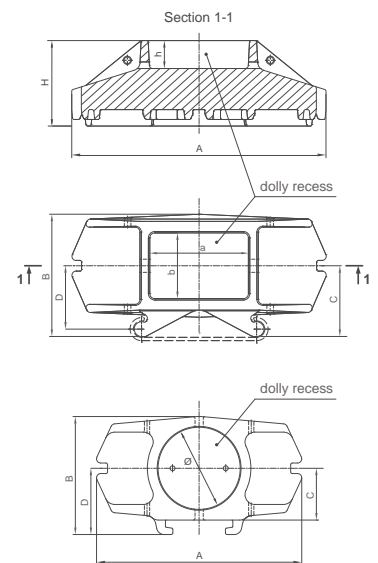

¹⁾ Availability to be checked with technical department.

Driving caps - Examples

Section 1-1 (UZD 14-28) [mm]

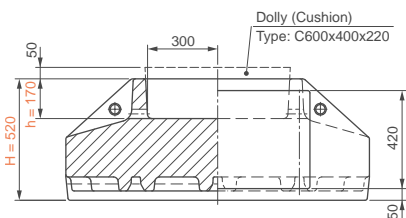

Plan view [mm]

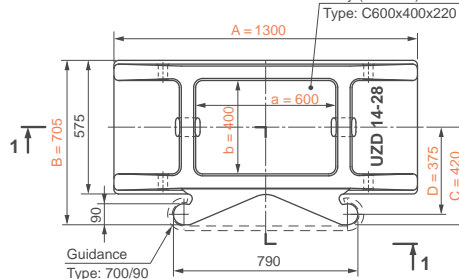

Bottom view

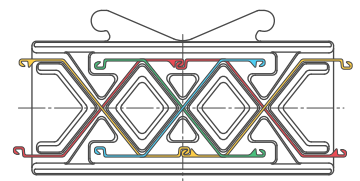

Position of section AZ 17-700... AZ 28-700 as single and double pile

Section 1-1 (PUD 17-33) [mm]

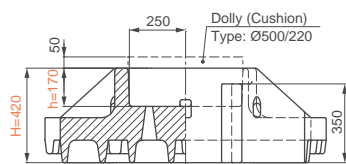

Plan view [mm]

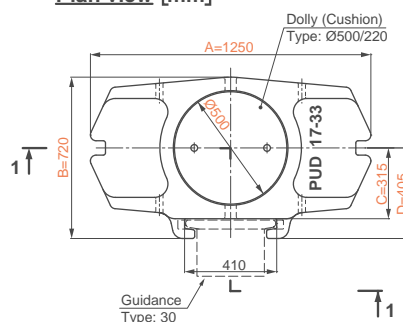

Bottom view

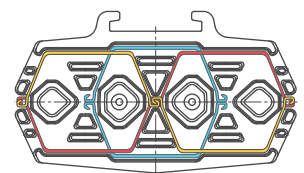

Position of section PU18...PU32 and GU13N...GU33N as single, double and box pile

Sheet pile sections and corresponding driving caps

Arrangement	D	D	D	D	D	D	D	S	D/B	D/B	S	S	D/T/B	D/T/B	D/B	S	D
Driving caps	AZD 12-14	AZD 12-14 L	UZD 14-28	AZD 36-40	A 18/26	ZD 800 A	ZD 800 B	AUS 14-26	AUD 12-16	AUD 20-32	PUS	US-B	UD 1	UD 2	PUD 17-33	HS 8-11	HD 6-11
Sections	AZD 12-14	AZD 12-14 L	UZD 14-28	AZD 36-40	A 18/26	ZD 800 A	ZD 800 B	AUS 14-26	AUD 12-16	AUD 20-32	PUS	US-B	UD 1	UD 2	PUD 17-33	HS 8-11	HD 6-11
AZ[®]-800																	
AZ 18-800							✓										
AZ 20-800							✓										
AZ 22-800							✓										
AZ 23-800																	✓
AZ 25-800																	✓
AZ 27-800																	✓
AZ[®]-750																	
AZ 28-750																	✓
AZ 30-750																	✓
AZ 32-750																	✓
AZ[®]-700 and AZ[®]-770																	
AZ 12-770		✓															
AZ 13-770		✓															
AZ 14-770		✓															
AZ 14-770-10/10		✓															
AZ 12-700	✓																
AZ 13-700	✓																
AZ 13-700-10/10	✓																
AZ 14-700	✓																
AZ 17-700			✓														
AZ 18-700			✓														
AZ 19-700			✓														
AZ 20-700			✓														
AZ 24-700			✓														
AZ 26-700			✓														
AZ 28-700			✓														
AZ 36-700N				✓													
AZ 38-700N				✓													
AZ 40-700N				✓													
AZ 42-700N				✓													
AZ 44-700N				✓													
AZ 46-700N				✓													
AZ 48-700				✓													
AZ 50-700				✓													
AZ 52-700				✓													
AZ[®]																	
AZ 18					✓												
AZ 18-10/10					✓												
AZ 26					✓												
AU[™]																	
AU 14		✓	✓														
AU 16		✓	✓														
AU 18		✓		✓													
AU 20		✓		✓													
AU 23		✓		✓													
AU 25		✓		✓				✓									
PU[®]																	
PU 12								✓	✓	✓							
PU 12S								✓	✓	✓							
PU 18 ⁻¹								✓					✓	✓			
PU 18								✓					✓	✓			
PU 18 ⁺¹								✓					✓	✓			
PU 22 ⁻¹								✓					✓	✓			
PU 22								✓					✓	✓			
PU 22 ⁺¹								✓					✓	✓			
PU 28 ⁻¹								✓	✓						✓		
PU 28								✓	✓						✓		
PU 28 ⁺¹								✓	✓						✓		
PU 32 ⁻¹								✓	✓				✓	✓			
PU 32								✓	✓				✓	✓			
PU 32 ⁺¹								✓	✓				✓	✓			
GU[®]																	
GU 6N								✓	✓	✓ ¹⁾							
GU 7N								✓	✓	✓ ¹⁾							
GU 7S								✓	✓	✓ ¹⁾							
GU 7HWS								✓	✓	✓ ¹⁾							
GU 8N								✓	✓	✓ ¹⁾							
GU 8S								✓	✓	✓ ¹⁾							
GU 10N													✓				
GU 11N													✓				
GU 12N													✓				
GU 13N								✓					✓	✓			
GU 14N								✓					✓	✓			
GU 15N								✓					✓	✓			
GU 16N								✓					✓	✓			
GU 18N								✓					✓	✓			
GU 20N								✓					✓	✓			
GU 21N								✓					✓	✓			
GU 22N								✓					✓	✓			
GU 23N								✓					✓	✓			
GU 27N								✓							✓		
GU 28N								✓							✓		
GU 30N								✓							✓		
GU 31N								✓	✓				✓	✓			
GU 32N								✓	✓				✓	✓			
GU 33N								✓	✓				✓	✓			
HZ[®]-M																	
HZ 630M																✓ ²⁾	✓ ²⁾
HZ 880M																✓	✓
HZ 1080M																✓	✓
HZ 1180M																✓	✓

¹⁾ Not fitting for box piles.

²⁾ On request.

S = Single pile
D = Double pile
T = Triple pile
B = Box pile

Sliding guides

Sliding guides are designed to guide the driving cap along the leader, thus guaranteeing proper alignment of the

hammer in the centre of the driving cap. Their adaptation to the leader is normally carried out on-site.

Dimensions

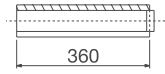
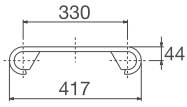

Designation

330/50

Corresponding driving caps

PUS
US-B

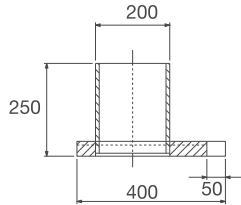
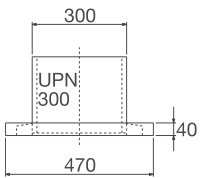

30

UD
PUD

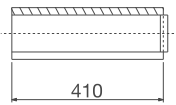
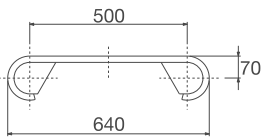

500/90

A
AUS
ZD 800 A-weld
ZD 800 B-weld
HS 8-11

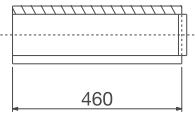
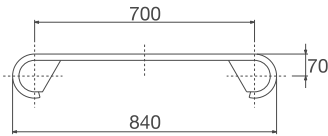

700/90

AUD
AZD
ZD 800 A
ZD 800 B
UZD
HD 6-11

Arrangement of driving caps

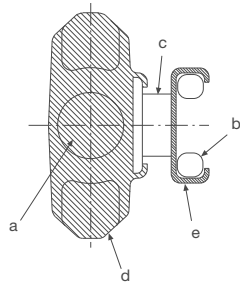
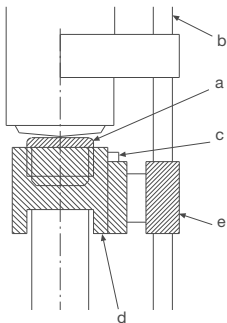

a = dolly/cushion
b = leader
c = sliding guide
d = driving cap
e = leader slide

The leader slide (e) is not provided by ArcelorMittal.



HP piles

HP piles are special H-shaped bearing piles with webs and flanges of the same thickness. They are used as bearing piles for foundation projects such as bridges and industrial facilities or as anchoring piles for quay or excavation walls.

HP piles have the following common characteristics:

- guaranteed pile integrity after installation. No length limitations due to trimming or splicing;
- easy to store, handle and install. Easy connection to superstructure;
- bearing capacity available right after installation, capacity can be determined during installation;
- excellent durability. Corrosion rates of embedded HP piles are extremely low;
- HP piles are able to take high tensile and bending forces.

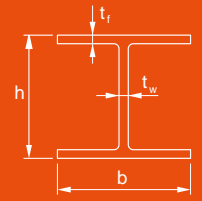

HP bearing piles range from HP 200 to HP 400. They are available in structural steel grades (yield strength 235 – 355 MPa) as well as in high-strength steel grades (yield strength 355 – 460 MPa), including HISTAR® quality.

Rolling tolerances on dimensions, shape, weight and length are fixed in accordance with EN 10034.

Minimum delivery length is 8 m, maximum delivery length is 24.1 m for HP 200/220/260 and 33.0 m for HP 305/320/360/400.

The table below shows a selection of available piles. Please refer to the brochure “Wide flange bearing piles” for detailed information on the entire HP range.

Section	Mass kg/m	Dimensions				Sectional area cm ²	Total area $A_{tot} = h \cdot b$ cm ²	Perimeter m	Moment of inertia		Elastic section modulus	
		h mm	b mm	t _w mm	t _f mm				y-y cm ⁴	z-z cm ⁴	y-y cm ³	z-z cm ³
HP 200 x 43	42.5	200	205	9.0	9.0	54.1	410	1.18	3888	1294	389	126
HP 220 x 57	57.2	210	225	11.0	11.0	72.9	472	1.27	5729	2079	546	185
HP 260 x 75	75.0	249	265	12.0	12.0	95.5	660	1.49	10650	3733	855	282
HP 305 x 110	110	308	311	15.3	15.4	140	955	1.80	23560	7709	1531	496
HP 320 x 117	117	311	308	16.0	16.0	150	958	1.78	25480	7815	1638	508
HP 360 x 152	152	356	376	17.8	17.9	194	1338	2.15	43970	15880	2468	845
HP 400 x 213	213	368	400	24.0	24.0	271	1472	2.26	63920	25640	3474	1282

t_w = t_{web} = web thickness

t_f = t_{flange} = flange thickness

Deurganckdock CT, Antwerp, Belgium



Durability of steel sheet piles

Unprotected steel in the atmosphere, water or soil is subject to corrosion that may lead to damage. Local weakening and rusting-through are normally considered to be maintenance problems that can be remedied locally. Depending on life-time requirements and accessibility to the structure, the service life of a steel structure can be achieved by one or a combination of following methods:

- protection by coating (typically only in high corrosion zones);
- use of a stronger section or a higher steel grade to create a "structural design reserve";

- use of Marine Grade Steel ASTM A690 (splash zone);
- avoiding important bending moments in the high corrosion zones;
- extension of the concrete capping beam below the low-water level;
- cathodic protection by impressed current or by sacrificial anodes (protects the surface constantly in contact with water);
- use of AMLoCor® steel grade (permanent immersion zone and low water zone).

Corrosion rates



The maximum steel stress in most maritime sheet pile structures is situated within the permanent immersion zone. The loss of thickness in this zone is considerably lower than in the high corrosion zones. Steel stress is generally very low in the maximum corrosion zones: splash zone & low water zone. These locations are therefore not the critical part of the structure despite their negative appearance if unprotected.

Typical loss of thickness due to corrosion and moment distribution for anchored sheet pile wall in marine environment:

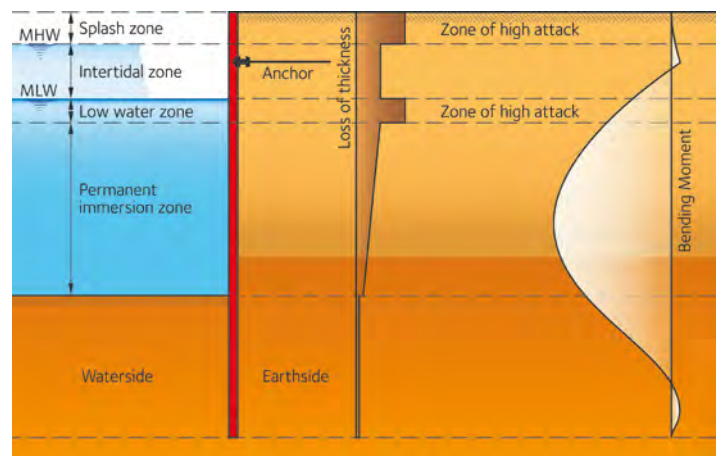

Please refer to EC 3 Part 5 (EN 1993-5) for details on loss of steel thickness as a result of exposure in different media. The use of the steel grade AMLoCor® significantly increases the design life of marine structures.

Surface coating

The classical corrosion protection for steel sheet piling is surface coating. EN ISO 12944 deals with protection by paint systems and its various parts cover all the features that are important in achieving adequate corrosion protection. It is essential that the steel surface is properly prepared before applying a coating system: removal of millscale by abrasive blasting (cf. ISO 8501-1). Most systems consist of one or two primers, an intermediate coat and a topcoat. Zinc primers are used frequently due to their good corrosion-inhibiting properties.

Intermediate coats increase the total thickness and thus increase the distance for moisture diffusion to the surface. Topcoats are chosen for colour and gloss retention, for chemical resistance, or for additional resistance to mechanical damage. Epoxies are generally used for seawater immersion and chemical resistance, polyurethanes for colour and gloss retention. Below, paint systems are proposed for different environments according to classifications of EN ISO 12944.

Metro Copenhagen, Denmark



Atmospheric exposure

Some applications require a stronger aesthetic component, where the steel sheet pile wall appearance is very relevant. In those cases, polyurethane finishes – which are easy to apply and maintain – are the preferred choice, mainly due to their good gloss and colour retention characteristics.

Proposal (EN ISO 12944 – Table A4, corrosivity category C4):

Epoxy primer
Recoatable epoxy intermediate coating
Aliphatic polyurethane topcoat

Nominal dry-film thickness of the system: 240 µm

Flood protection wall, Hamburg, Germany



Sea water & fresh water immersion Im1 / Im2

For long-term performance of steel structures immersed in sea water and in fresh water there should be no compromise on quality of the coating system, particularly as it may be damaged due to abrasion and impact. The application must be properly carried out and inspected on a regular basis. Cathodic protection is sometimes specified in combination with a (fully compatible) coating system.

Proposal (EN ISO 12944 – Table A6, corrosivity category Im2)

Epoxy primer

Solvent-free epoxy coating or epoxy glass flake

Nominal dry-film thickness of the system: 500-550 µm

Lock, Venice, Italy



Landfills and contaminated soils

Excellent protection is essential due to exposure to highly aggressive substances. The coating system must have outstanding resistance to mineral and organic acids and other chemicals as well as capacity to withstand abrasion and impacts.

Proposal

Micaceous iron oxide pigmented polyamide cured epoxy primer
Polyamide-cured-epoxy coating with increased chemical resistance

Nominal dry-film thickness of the system: 480 µm

Waste disposal, Horn, Austria



AMLoCor®

New corrosion resistant steel grade for marine applications

AMLoCor® is ArcelorMittal's "low corrosion" steel grade that will revolutionize the design of port structures in the future.

The **key advantage of AMLoCor®** is a significant reduction of the corrosion rates in the "Low Water Zone" (LWZ) and in the "Permanent Immersion Zone" (PIZ), which is normally the location of the maximum bending moments and consequently highest steel stresses. This steel grade is the solution to address the major concern of designers and port authorities: **durability of marine structures** like quay walls, breakwaters and jetties.

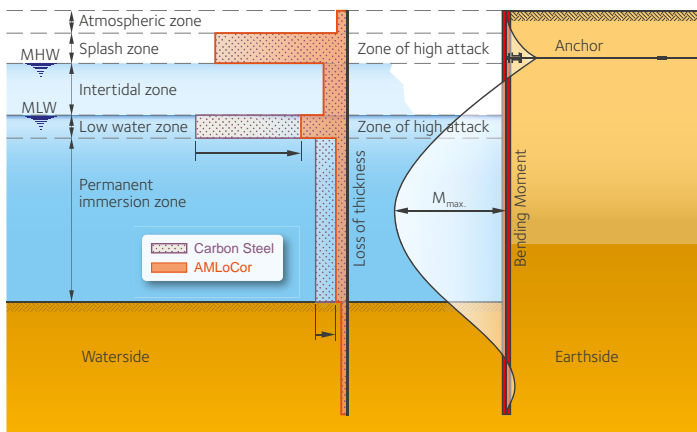

Typical loss of steel thickness in a marine environment: regular carbon steel vs. AMLoCor®.

Eurocode 3 Part 5 contains reference tables with typical corrosion rates valid for standard carbon steel in northern European countries. In-situ tests have proven that the **loss of steel thickness of AMLoCor is reduced by a factor 3 (PIZ) to 5 (LWZ) compared to standard structural steel** in the critical zones.

AMLoCor leads to considerable savings in steel weight compared to the unprotected carbon steel piling solution, as soon as loss of steel thickness due to corrosion in the immersion zone is significant. Cathodic protection or coatings can be used to increase the service life of the sheet pile structure. However, **AMLoCor® will in many cases yield the most cost-effective solution in the long-term.** AMLoCor is compatible with cathodic protection and coatings.

In addition AMLoCor protects the structures from "ALWC" (Accelerated Low Water Corrosion) which is related to biological activity enhancing degradation of steel in the low water zone.

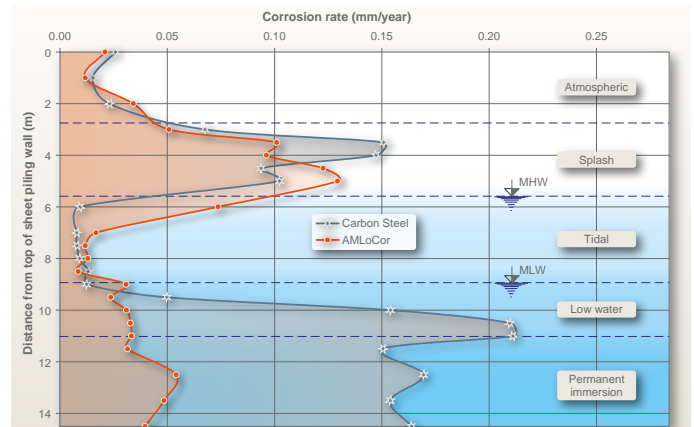

Steel grades AMLoCor are covered by the German National Technical Approval Z-30.10-55 of the "Deutsche Institut für Bautechnik (DIBt)".

The mechanical properties of AMLoCor steel are fully equivalent to standard piling grades, so that structural resistance can be determined according to all relevant design codes used for steel sheet piling structures, like EN 1993-5:2007 in European countries.

Some AZ sections are already available in AMLoCor steel grades, ranging from **AMLoCor Blue 320 to Blue 390** (yield strength 320 MPa up to 390 MPa). Please check our website for regular updates on available sections.

A driving test was performed in very compact soil in Denmark. Sheet piles in S 355 GP and AMLoCor Blue 355 were driven into very hard soils with some boulders. The sheet piles were monitored during driving, then pulled out and inspected. This test has demonstrated that the behaviour of AMLoCor sheet piles is equivalent to regular carbon steel sheet piles.

For more detailed information (e.g. on welding) please check our **brochure "AMLoCor®"**.

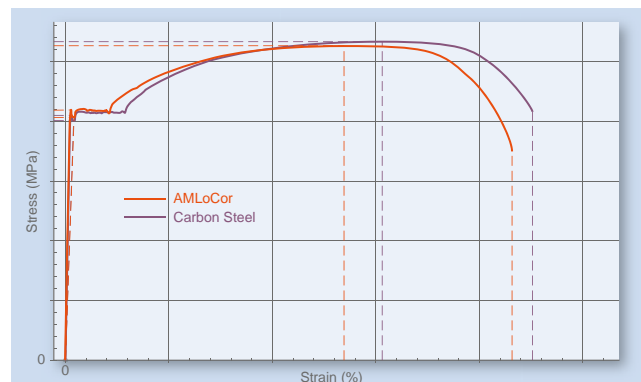

Typical Stress - Strain diagram of carbon steel & AMLoCor®.

Watertightness

Steel sheet piles are completely impervious. The only possibility of water infiltrating through a sheet pile wall is by penetration through the interlock. Due to its shape, the Larssen interlock naturally provides high seepage resistance. Sealing systems are therefore not necessary for applications such as temporary retaining walls where moderate rates of seepage are acceptable. If medium to high seepage resistance is required, e.g. cut-off walls for contaminated sites, retaining structures for bridge abutments or tunnels, double sheet piles with sealed or welded joints are recommended. **Please refer to our brochure “The impervious sheet pile walls” for further details.**

The following sealing systems are used to increase the watertightness of sheet pile walls:

- bituminous filler: **Beltan® Plus**,
maximal water pressure: 100 kPa;
- wax & mineral-oil-based filler: **Arcoseal™**,
maximal water pressure: 100 kPa;
- water-swelling product: **ROXAN® Plus System**,
maximal water pressure: 200 kPa;
- **AKILA® System**,
maximal water pressure: 300 kPa;
- welding: 100% watertight.

As Darcy’s law for discharge through homogenous structures is not applicable to leakage phenomenon through sheet pile interlocks, a new concept of "joint resistance" has been developed by GeoDelft (Deltares).

$$q(z) = \rho \cdot \Delta p(z) / \gamma_w$$

- $q(z)$ water discharge [$\text{m}^3/\text{s}/\text{m}$]
- ρ inverse joint resistance [m/s]
- $\Delta p(z)$ pressure drop at level z [kPa]
- γ_w unit weight of water [kN/m^3]

Sealing system/method	ρ [$10^{-10} \text{m}/\text{s}$]			Application of the system	Cost ratio ¹⁾
	100 kPa	200 kPa	300 kPa		
No sealant	> 1000	–	–	–	0
Beltan® Plus	< 600	not recommended	–	easy	1.0
Arcoseal™	< 600	not recommended	–	easy	1.2
ROXAN® Plus	0.5	0.5	–	with care	1.8
AKILA®	0.3	0.3	0.5	with care	2.1
Welded interlocks	0	0	0	2)	5.0

¹⁾ Cost ratio = $\frac{\text{Cost of sealing system}}{\text{Cost of Beltan® Plus Solution}}$

²⁾ After excavation for the interlock to be threaded on jobsite.

Excavation for an office building, Amsterdam, The Netherlands



AKILA® sealing system

AKILA® is an **environment-friendly high performance sealing system** for ArcelorMittal steel sheet piles. The system is based on three sealing "lips" mechanically extruded into the free interlocks using a product called MSP-1. The common interlock of double piles is sealed with a second product called MSP-2.

MSP-1 and MSP-2 belong to the family of **silane modified polymers** (MS-Polymers). Both products are resistant to humidity and weathering. Their main characteristics are:

- **single component elastic sealants** with a density of
 - 1.41 g/cm³ for MSP-1;
 - 1.48 g/cm³ for MSP-2;
- UV-stable;
- **excellent adhesion to steel**;
- resist to temperatures between -40 °C and +90 °C (up to 120 °C for short periods);
- elongation at break > 380%;
- Shore A hardness after complete polymerization
 - 58 for MSP-1;
 - 44 for MSP-2 (after 14 days);
- durable in contact with freshwater, seawater as well as various hydrocarbons, bases and acids (depending on concentration – a complete list is available on request).

Inverse joint resistance ρ_m

A series of in-situ tests were carried out in stiff clays and in soft sandy soils. Single and crimped double sheet piles, fitted out with the AKILA® system, were driven into the ground using an impact hammer as well as a vibratory hammer.

In case of vibrodriving, sheet piles were driven continuously at a minimum penetration rate of 3 meters per minute. After installation, watertightness was tested at **water pressures of 2 and 3 bar**, according to a procedure developed by Delft Geotechnics (Deltares) and ArcelorMittal. The testing and the results were witnessed and certified by "Germanischer Lloyd", an independent third party.

The average **inverse joint resistance ρ_m** was determined according to EN 12063, see table below.

Water pressure	ρ_m (m/s)	
	200 kPa	300 kPa
Single piles (MSP-1)	4.9×10^{-11}	8.6×10^{-11}
Double piles (MSP-1 & MSP-2)	3.3×10^{-11}	4.7×10^{-11}

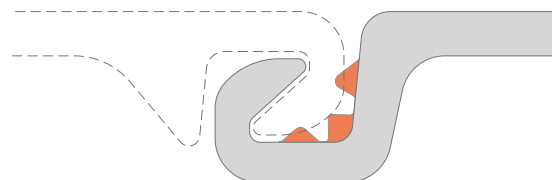

Sketch of MSP-1 product extruded into the free interlock.

MS-Polymers are solvent free and do not contain isocyanates. They can be considered environment-friendly products. AKILA® is certified by the "Hygiene-Institut des Ruhrgebiets" in Germany as suitable for use in contact with groundwater.

The free interlocks have to be chamfered at the top (see sketch). Penetration of soil into the interlocks during driving should be prevented, for instance by inserting a bolt at the bottom of the interlock (bolt tack welded). The ambient temperature during installation must be above 0 °C. Additionally, to improve the sliding of the interlocks, an environment-friendly lubricant must be applied to the sealant in the interlocks prior to driving. The layout and driving direction of the sheet pile wall shall be determined before ordering the sheet piles (delivery form of double piles, chamfering of interlocks, etc.).

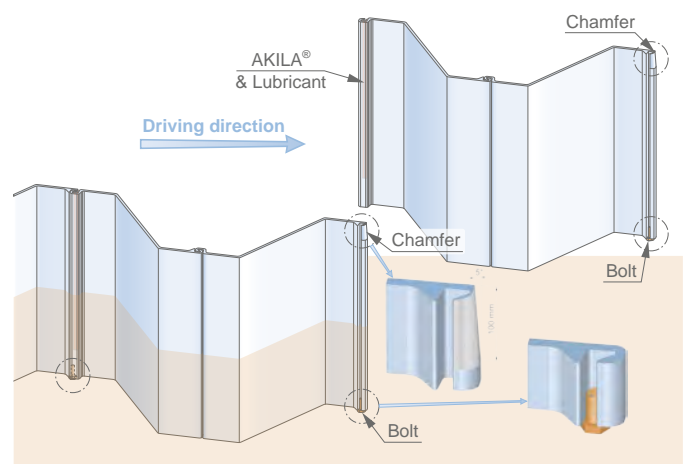

Installation recommendations (driving direction, chamfer, etc.).

For more information contact our technical department.

Sustainability & Environmental Product Declaration (EPD)

ArcelorMittal champions steel's ability to create high quality, sustainable lifestyles for people all over the world. In 2010, it was the first steel manufacturer that performed a Life Cycle Assessment (LCA) dedicated to steel sheet piles. ArcelorMittal's hot rolled and cold formed steel sheet piles are covered by several Environmental Product Declarations (EPD). Its first EPD was published in 2016.

ArcelorMittal's brand values are sustainability, quality and leadership. ArcelorMittal Sheet Piling understands how the world is evolving, not only from an economic and market perspective, but also in terms of the social and environmental trends that will shape our future. Our goal is to supply cost-effective and sustainable solutions that take into account society's expectations

Circular economy

ArcelorMittal Sheet Piling is also a major actor in the circular economy, promoting greater resource productivity, aiming to reduce waste and avoid pollution. This contrasts with a linear take-make-dispose economy, which wastes



Quality management and certifications

Customer satisfaction is our main goal. Our mills are certified in accordance to international standards ISO 9001, ISO 14001, ISO 50001, ISO 45001

ArcelorMittal's EcoSheetPile™ label

The EcoSheetPile™ label certifies that the steel sheet piles manufactured are produced

Life Cycle Assessment (LCA)

Developed in the 1990's, the Life Cycle Assessment is a standardised methodology that analyses the environmental impacts of a product or a service during its production, use phase and end-of-life (ISO 14040). It is an important tool to the steel industry as a way to assess and quantify the environmental footprint of steel products

about the preservation of our planet.

ArcelorMittal's steel sheet piles are an environment-friendly construction product produced in European facilities that report transparent indicators of their environmental performance, and have certified quality management systems. Health & Safety of every employee is a top priority in our production facilities.

large amounts of resources, energy, and labour. One of the main objectives of circular economy is to reduce waste systematically throughout the different life cycles of a product. Circular economy refers usually to numerous R's: Reduce, Reuse, Remanufacture, Recycle, ...

Steel is a permanent material: never consumed, but continuously transformed; the use of natural resources for producing steel the first time is therefore a transformative process, making iron available in a more "practical form" for subsequent uses (life cycles).

ArcelorMittal has been optimizing its sheet piles for more than 100 years to reduce the consumption of raw materials. For instance, using the latest AZ-800 range saves up to 10% of steel compared to an equivalent profile from the AZ-700 range. Additionally, steel sheet piles can be reused up to 10 times in temporary applications. Finally, 100% can be recovered and 100% can be recycled. 100% of the steel produced in our Luxembourgish mills is made out of steel scrap (recycling process).

as well as BES 6001. This is essential to maintain the high quality of our products and to develop innovative solutions.

from 100% of recycled steel, are 100% recyclable, and are reusable.



along their entire life cycle, from the sourcing of the natural resources, to its end-of-life and recycling phase. When performing an LCA it is also important to define the frame in which the assessment is made. An LCA can be used to compare the environmental impact of different solutions and/or products from different manufacturers.

Environmental Product Declaration (EPD)

An EPD is a verified and registered document that communicates transparent data about the life cycle environmental impact of one or more products. It is usually developed by the manufacturer, peer reviewed by independent bodies on the basis of ISO 14025 and EN 15804 standards, and published by an official environmental labelling organisation. Thus, EPDs provide suitable and objective data that can be used in public procurement processes.



Steel sheet piles' EPDs

ArcelorMittal's sheet piles are covered by one of the three EPDs registered at the Institut Bauen und Umwelt e.V. (IBU), Germany, in accordance with the current European standards, and accepted by the ECO PLATFORM.

ArcelorMittal analysed the full production process and performed a Life Cycle Assessment of its steel sheet piles.

ArcelorMittal's EPDs are of the type "cradle-to-gate with options". They consider the different steps of the steel making process ("cradle to gate"), and additional "options". The EPDs take into account the following boundary conditions:

- resources: provision of resources, additives and energy;
- transportation of resources and additives to the production site;
- steel making process analysis on site, including energy, production of additives, disposal and valorisation of production residues, and consideration of related emissions;
- waste processing (after-use);
- end-of-life scenarios: reuse and recycling.

Our EPDs contain the following modules:

- A1-A3: structural steel production;
- C3: sorting and shredding of after-use steel, non-recovered scrap due to sorting efficiency;
- D: End-of-Life scenarios, including reuse and recycling.

All the data used in the LCA was collected through recommended templates developed by World Steel Association and its experts for Life Cycle Inventories (LCI) purpose.

The data of the different sites was cross-checked and compared to the previous years' data to identify potential inconsistencies. All the processes, materials and emissions that are known to make a significant contribution to the environmental impact were considered. It comprises used materials, thermal energy, electrical energy and fuel consumption as well as emissions from on-site measurements.

Steel sheet piles can be reused several times and recycled at the end of life. The assumption made in our EPDs for hot rolled sheet piles is that for each tonne produced, 25%

will be reused, 74% directly recycled after the first use, and 1% will be landfilled. Overall, 99% of the sheet piles will be recycled after their service life (varying from a few years for temporary applications to over 100 years for permanent applications), and only 1% leaves the system (landfill).

Although the period in which the steel sheet piles are used in their different applications is not defined in the EPD, it is important to define their service life to highlight their durability as a construction material. Steel sheet piles can be designed for 50 years and more, and there are documented cases of sheet pile walls built in the early 20th century that are still in use.

ArcelorMittal has published 3 EPDs since 2016.

The declared unit is always 1 tonne of steel sheet piles.

1. The generic "*Hot rolled steel sheet piling*" EPD was published in 2016 and covers hot rolled steel sheet piles (AZ[®], AU[™], PU[®], GU[®], AS 500[®] and HZ[®]-M) produced by ArcelorMittal in the plants of Belval (Luxembourg), Differdange (Luxembourg) and Dabrowa (Poland). It is based on a mix of the Electric Arc Furnace (EAF) route and on the blast furnace (BOF) route. It covers 100% of the annual production volumes of 2015.
2. The "*EcoSheetPile™*" EPD was published in 2018 and covers hot rolled steel sheet piles (AZ[®], AU[™], PU[®], AS 500[®] and HZ[®]-M) produced by ArcelorMittal in the plants of Belval (Luxembourg) and Differdange (Luxembourg). It is based on the Electric Arc Furnace (EAF) route: 100% of recycled material. The data refers to the production volumes of 2015.
3. The "*Cold formed steel sheet piles*" EPD published in 2019 covers cold formed steel sheet piles (PAZ[™], PAL[™], PAU[™] and trench sheets) manufactured by ArcelorMittal in its plant in Messempré (France). It uses data collected from the steel shops producing the coils (Dunkerque in France, Ostrava in the Czech Republic). It is based on the blast furnace (BOF) route. Data collected from the cold forming mill is also considered. The data refers to the production volumes of 2017.

Note: a comparison or an evaluation of EPD data is only possible if all the data sets to be compared were created according to EN 15804 and if the building context, respectively the product-specific characteristics of performance, are taken into account. The fairest and most objective method to compare different alternatives is to perform an LCA based on the data provided in the EPD of the manufacturer of the product.

Delivery conditions

Tolerances on shape and dimensions of hot rolled steel sheet piles according to EN 10248 (reduced tolerances on request)

Tolerances	AU™, PU®, GU®	AZ®	AS 500®	HZ®-M
Mass ¹⁾	± 5%	± 5%	± 5%	± 5%
Length (L)	± 200 mm	± 200 mm	± 200 mm	± 200 mm
Height (h) ²⁾	h ≤ 200 mm: ± 4 mm h > 200 mm: ± 5 mm	h ≥ 300 mm: ± 7 mm	-	h ≥ 500 mm: ± 7 mm
Thicknesses (t,s)	t, s ≤ 8.5 mm: ± 0.5 mm t, s > 8.5 mm: ± 6%	t, s ≤ 8.5 mm: ± 0.5 mm t, s > 8.5 mm: ± 6%	t > 8.5 mm: ± 6%	t, s > 12.5 mm: -1.5 mm / +2.5 mm
Width single pile (b)	± 2% b	± 2% b	± 2% b	± 2% b
Width double pile (2b)	± 3% (2b)	± 3% (2b)	± 3% (2b)	± 3% (2b)
Straightness (q)	≤ 0.2% L	≤ 0.2% L	≤ 0.2% L	≤ 0.2% L
Ends out of square	± 2% b	± 2% b	± 2% b	± 2% b

¹⁾ From the mass of the total delivery. ²⁾ Of single pile.

Maximum rolling lengths (longer sections available on request)

Section	AZ	AU, PU	GU ¹⁾	AS 500	HZ-M	RH / RZ	OMEGA 18	C9 / C14	DELTA 13
Length [m]	31	31	28	31	33	24	16	18	17

¹⁾ Contact us for detailed information.

Handling holes

Sheet pile sections are normally supplied without handling holes. If requested, they can be provided with handling holes in the centerline of the section. The standard handling hole dimensions are as follows:

Diameter D [mm]	40	40	50	50	63.5	40
Distance Y [mm]	75	300	200	250	230	150

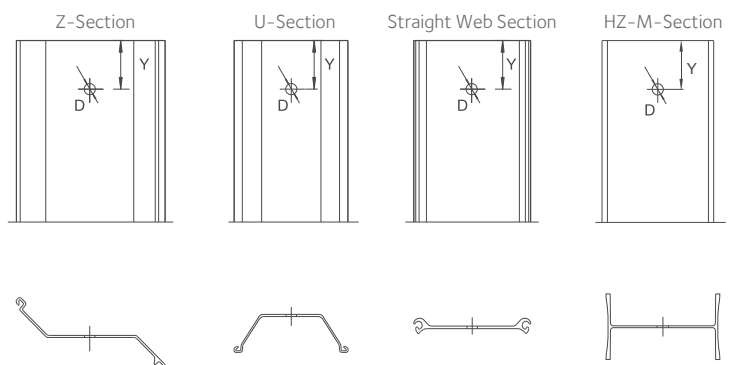

Markings

The following markings can be supplied on request:

- colour marks defining section, length and steel grade;
- adhesive stickers showing the customer's name, destination, order and item number, type and length of profile and steel grade.

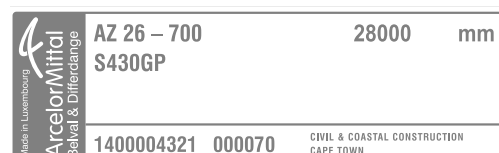

Steel grades of sheet pile sections

Steel grade EN 10248	Min. yield strength R _{eH} MPa	Min. tensile strength R _m MPa	Min. elongation L ₀ =5.65√S ₀ %	Chemical composition ¹⁾ (% max)					
				C	Mn	Si	P	S	N ^{2), 3)}
S 240 GP	240	340	26	0.25	–	–	0.055	0.055	0.011
S 270 GP	270	410	24	0.27	–	–	0.055	0.055	0.011
S 320 GP	320	440	23	0.27	1.70	0.60	0.055	0.055	0.011
S 355 GP	355	480	22	0.27	1.70	0.60	0.055	0.055	0.011
S 390 GP	390	490	20	0.27	1.70	0.60	0.050	0.050	0.011
S 430 GP	430	510	19	0.27	1.70	0.60	0.050	0.050	0.011

ArcelorMittal mill specification

S 460 AP	460	550	17	0.27	1.70	0.60	0.050	0.050	0.011
----------	-----	-----	----	------	------	------	-------	-------	-------

AMLoCor®	Min. yield strength R _{eH} MPa	Min. tensile strength R _m MPa	Min. elongation L ₀ =5.65√S ₀ %	Chemical composition ¹⁾ (% weight)							
				(% max.)						(% min.)	
				C	Mn	Si	P	S	N ^{2), 3)}	Cr	Al
Blue 320	320	440	23	0.27	1.70	0.60	0.05	0.05	0.011	0.75	0.40
Blue 355	355	480	22	0.27	1.70	0.60	0.05	0.05	0.011	0.75	0.40
Blue 390	390	490	20	0.27	1.70	0.60	0.05	0.05	0.011	0.75	0.40

All the sections can be delivered in steel grades according to EN 10248-1, but not all sections are available in all steel grades. Below table summarizes the current possibilities. Special steel grades like **S 460 AP**, American **ASTM A 572** steel grades, steels with improved corrosion resistance like **AMLoCor** and **ASTM A 690**, or steels with copper addition in accordance with EN 10248 Part 1 Chapter 10.4 can be supplied on request. A modified steel grade A 690 with higher yield strength is also available upon request.

Please contact us for information.

Galvanisation has an influence on the required chemical composition of the steel and must therefore be specified in the purchase orders.

We strongly recommend informing us of all surface treatments to be applied to the product when placing orders.

ArcelorMittal can also provide steel grades complying with other standards (see table below).

Europe	EN 10248	S 270 GP	S 320 GP	S 355 GP	S 390 GP	S 430 GP	S 460 AP
USA	ASTM	A 328	–	A 572 Gr. 50; A 690	A 572 Gr. 55	A 572 Gr. 60	A 572 Gr. 65
Canada	CSA	Gr. 260 W	Gr. 300 W	Gr. 350 W	Gr. 400 W	–	–
Japan	JIS	SY 295	–	–	SY 390	–	–

Section	EN 10248							ASTM		AMLoCor®		
	S 240 GP	S 270 GP	S 320 GP	S 355 GP	S 390 GP	S 430 GP	S 460 AP	A 572	A 690	Blue 320	Blue 355	Blue 390
AZ-700 to 800	✓ ⁴⁾	✓	✓	✓	✓	✓	✓	✓	✓	✓	✓	✓
AZ	✓ ⁴⁾	✓	✓	✓	✓	✓	✓	✓	✓	✓	✓	✓
AU	✓ ⁴⁾	✓	✓	✓	✓	✓	✓	✓	✓	✓	✓	✓
PU	✓ ^{4), 5)}	✓ ⁵⁾	✓ ⁵⁾	✓	✓	✓ ⁶⁾	✓ ⁶⁾	✓	✓ ⁶⁾	✓	✓	✓
GU-N/S	✓ ⁴⁾	✓	✓	✓	✓	✓	✓ ⁷⁾	❖	✗	✓	✓	✓
GU-400	✓ ⁴⁾	✓	✓	✓	✓	❖	❖	❖	✗	✓	✓	✓
HZ-M	✓ ⁴⁾	✓	✓	✓	✓	✓	✓ ⁸⁾	✓	✓	✓	✓	✗
RH / RZD / RZU	✗	✗	✗	✗	✗	✓	✓	✗	✓	✓	✓	✗
C 9	✗	✗	✗	✓	✗	✗	✗	✓	✗	✓	✓	✗
C 14	✗	✗	✗	✓	✗	✗	✗	✗	✗	✓	✓	✗
Delta 13	✗	✗	✗	✓	✗	✗	✗	✗	✗	✓	✓	✓
Omega 18	✗	✗	✗	✗	✗	✓	✓	✗	✗	✗	✓	✗
AZ 20-800										✓	✓	✓
AZ 19-700										✓	✓	✓
AZ 20-700										✓	✓	✓
AZ 26-700										✓	✓	✓
AZ 28-700										✓	✓	✓
AZ 38-700N										✓	✓	✗
AZ 40-700N										✓	✓	✗
AZ 44-700N										✓	✓	✗
AZ 46-700N										✓	✓	✗
AZ 26										✓	✓	✓
C 9										✗	✓	✗

¹⁾ Product analysis. Maximum copper content of 0.6% for non-alloyed steel.

²⁾ It is permissible to exceed the specific values provided that for each increase of 0.001% N, the P max content will be reduced by 0,005%. However, the N content shall not exceed 0.012% on the ladle analysis and 0.014% on the product analysis.

³⁾ The maximum value for nitrogen does not apply if the chemical composition shows a minimum total Al content of 0.020% or if sufficient other N binding elements are present.

⁴⁾ Please contact us as some limitations may apply.

⁵⁾ Except PU 12 & derivatives.

⁶⁾ PU 12 & derivatives on request.

⁷⁾ GU 11N & derivatives on request.

⁸⁾ HZ 1180M C and HZ 1180M D on request.

✓ Available.

❖ On request.

✗ Currently unavailable.

Geometric tolerances of tubular piles

Tolerance on pile length: ± 200 mm

Standard	Outside diameter D	Wall thickness t	Straightness	Out-of-roundness	Mass	Maximum weld bead height ¹⁾
EN 10219-2	$\pm 1\%$ ± 10.0	$\pm 10\%$ ± 2.0	0.20% of total length	$\pm 2\%$	$\pm 6\%$	$t \leq 14.2$: 3.5 $t > 14.2$: 4.8

¹⁾ Tolerance on height of internal and external weld bead for submerged arc-welded hollow sections.
Note: values in "mm" except where specified.

Steel grades of tubular pile

Steel grade EN 10219-1	Min. yield strength R_{eH} ($t \leq 16$ mm) MPa	Min. yield strength R_{eH} ($16 < t \leq 40$ mm) MPa	Min. tensile strength R_m ($3 \leq t \leq 40$ mm) MPa	Min. elongation L_0 ($t \leq 40$ mm) %	Chemical composition (% max)						
					C	Mn	P	S	Si	N	CEV ($t \leq 20$ mm)
S 235 JRH	235	225	340-470	24	0.17	1.40	0.040	0.040	-	0.009	0.35
S 275 JOH	275	265	410-560	20	0.20	1.50	0.035	0.035	-	0.009	0.40
S 355 JOH	355	345	490-630	20	0.22	1.60	0.035	0.035	0.55	0.009	0.45
S 420 MH	420	400	500-660	19	0.16	1.70	0.035	0.030	0.50	0.020	0.43
S 460 MH	460	440	530-720	17	0.16	1.70	0.035	0.030	0.60	0.025	-

Steel grade API 5L, PSL 1 ¹⁾ ISO 3183	Min. yield strength R_{eH} MPa	Min. tensile strength R_m MPa	Min. elongation ²⁾ %	Chemical composition for pipe with $t \leq 25.0$ mm ⁴⁾ (% max)			
				C ³⁾	Mn ³⁾	P	S
L 245 or B	245	415	23	0.26	1.20	0.030	0.030
L 290 or X 42	290	415	23	0.26	1.30	0.030	0.030
L 320 or X 46	320	435	22	0.26	1.40	0.030	0.030
L 360 or X 52	360	460	21	0.26	1.40	0.030	0.030
L 390 or X 56	390	490	19	0.26	1.40	0.030	0.030
L 415 or X 60	415	520	18	0.26 ⁵⁾	1.40 ⁵⁾	0.030	0.030
L 450 or X 65	450	535	18	0.26 ⁵⁾	1.45 ⁵⁾	0.030	0.030
L 485 or X 70	485	570	17	0.26 ⁵⁾	1.65 ⁵⁾	0.030	0.030

¹⁾ API 5L (2018): American Petroleum Institute. PSL 1 (Product Specification Level 1): Composition according to specification.

²⁾ Minimum elongation: depends on tensile test piece cross-sectional area.

³⁾ For each reduction of 0.01 % below the specified max C concentration, an increase of 0.05 % above the specified max Mn concentration is permissible, up to a max of 1.65 % for grades L245/B to L360/X52, 1.75 % for L390/X56 to L450/X65 and 2.00 % for L485/X70.

⁴⁾ 0.50 % max for Cu, 0.50 % max for Ni, 0.50 % max for Cr, 0.15 % max for Mb.

⁵⁾ Unless otherwise agreed.

Tubular pile mill, Dintelmond, The Netherlands



Documentation

Please refer to our website to download all our documentation: sheetpiling.arcelormittal.com
or contact us via E-mail: sheetpiling@arcelormittal.com

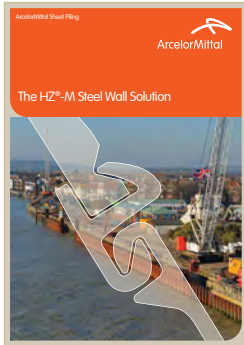

The HZ[®]-M Steel Wall System
GB



AS 500[°] Straight web steel sheet piles. Design and Execution.
GB



Spirally welded steel pipes
GB



HP bearing piles
GB, DE, FR, SP



Cold formed steel sheet piles
GB, DE, FR, NL



Harbour construction
GB



Underground car parks
GB, PT

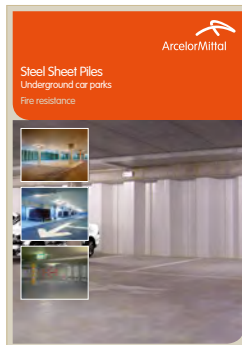

Underground car parks
Fire resistance
GB



High speed line south – NL
GB, FR, NL



Environmental
Product Declaration
GB



Installation of sheet piles
GB, DE, FR



Jetting-assisted sheet pile driving
GB, DE, FR



ANCHORS FOR
MARINE STRUCTURES
ANKER
SCHROEDER
GB, DE



Off-centre anchoring
GB, DE, FR



Impervious steel sheet pile walls
Design & Practical approach
GB, DE, FR



Piling Handbook
GB



Declutching detector
GB, DE, FR

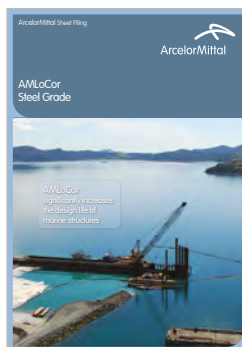

AMLoCor Steel Grade
GB, DE, RU



AZ sheet piles in combined walls
GB, DE, FR

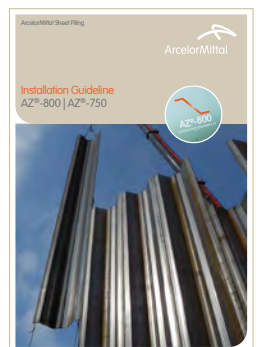

Installation Guideline
AZ[®]-800 | AZ[®]-750
GB, DE

Trademarks

ArcelorMittal is the owner of following trademark applications or registered trademarks:

“AS 500”, “AU”, “AZ”, “GU”, “HZ”, “HZ-M”, “HZ/AZ”, “PU”, “AMLoCor”, “AKILA”, “Beltan”, “ROXAN”, “Arcoseal”, “HISTAR”.

In communications and documents the symbol [™] or [®] must follow the trademark on its first or most prominent instance, for example:
AZ[®], AU[™]

Credit lines must be used on all communications and documents where a trademark is used, for example:

AZ is a trademark of ArcelorMittal group

AU, AZ and HZ are trademarks of ArcelorMittal group

AZ 26-700 is a steel sheet pile manufactured by ArcelorMittal group

Edition 11.2020 – Printed in Luxembourg

Printed on FSC paper.

The FSC label certifies that the wood comes from forests or plantations that are managed in a responsible and sustainable way (the FSC principles promote the social, economical, environmental and cultural needs of today's and the next generations).

www.fsc.org

ArcelorMittal Commercial RPS S.à r.l.
Sheet Piling

66, rue de Luxembourg
L-4221 Esch-sur-Alzette (Luxembourg)

E sheetpiling@arcelormittal.com
sheetpiling.arcelormittal.com



Hotline: (+352) 5313 3105



[ArcelorMittalSP](#)



[ArcelorMittal Sheet Piling \(group\)](#)